

- **Member of the Pin-Compatible CommsDAC™ Product Family**
- **125 MSPS Update Rate**
- **14-Bit Resolution**
- **Spurious Free Dynamic Range (SFDR) to Nyquist at 40 MHz Output: 63 dBc**
- **1 ns Setup/Hold Time**
- **Differential Scalable Current Outputs: 2 mA to 20 mA**
- **On-Chip 1.2 V Reference**
- **3 V and 5 V CMOS-Compatible Digital Interface**
- **Straight Binary or Twos Complement Input**
- **Power Dissipation: 175 mW at 5 V, Sleep Mode: 25 mW at 5 V**
- **Package: 28-Pin SOIC and TSSOP**

**SOIC (DW) OR TSSOP (PW) PACKAGE
(TOP VIEW)**

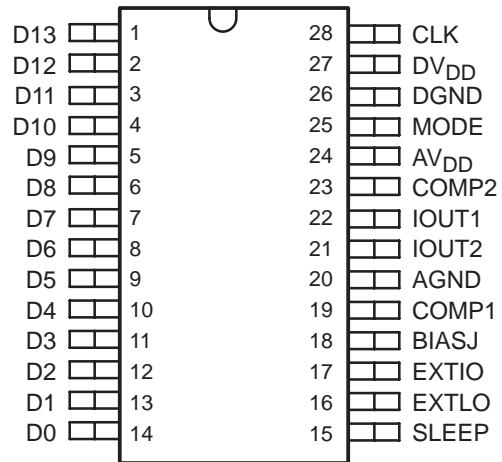

description

The THS5671A is a 14-bit resolution digital-to-analog converter (DAC) specifically optimized for digital data transmission in wired and wireless communication systems. The 14-bit DAC is a member of the CommsDAC series of high-speed, low-power CMOS digital-to-analog converters. The CommsDAC family consists of pin compatible 14-, 12-, 10-, and 8-bit DACs. All devices offer identical interface options, small outline package, and pinout. The THS5671A offers superior ac and dc performance while supporting update rates up to 125 MSPS.

The THS5671A operates from an analog supply of 4.5 V to 5.5 V. Its inherent low power dissipation of 175 mW ensures that the device is well-suited for portable and low-power applications. Lowering the full-scale current output reduces the power dissipation without significantly degrading performance. The device features a SLEEP mode, which reduces the standby power to approximately 25 mW, thereby optimizing the power consumption for system needs.

The THS5671A is manufactured in Texas Instruments advanced high-speed mixed-signal CMOS process. A current-source-array architecture combined with simultaneous switching shows excellent dynamic performance. On-chip edge-triggered input latches and a 1.2 V temperature-compensated bandgap reference provide a complete monolithic DAC solution. The digital supply range of 3 V to 5.5 V supports 3 V and 5 V CMOS logic families. Minimum data input setup and hold times allow for easy interfacing with external logic. The THS5671A supports both a straight binary and twos complement input word format, enabling flexible interfacing with digital signal processors.

The THS5671A provides a nominal full-scale differential output current of 20 mA and >300 kΩ output impedance, supporting both single-ended and differential applications. The output current can be directly fed to the load (e.g., external resistor load or transformer), with no additional external output buffer required. An accurate on-chip reference and control amplifier allows the user to adjust this output current from 20 mA down to 2 mA, with no significant degradation of performance. This reduces power consumption and provides 20 dB gain range control capabilities. Alternatively, an external reference voltage and control amplifier may be applied in applications using a multiplying DAC. The output voltage compliance range is 1.25 V.



Please be aware that an important notice concerning availability, standard warranty, and use in critical applications of Texas Instruments semiconductor products and disclaimers thereto appears at the end of this data sheet.

CommsDAC is a trademark of Texas Instruments Incorporated.

PRODUCTION DATA information is current as of publication date. Products conform to specifications per the terms of Texas Instruments standard warranty. Production processing does not necessarily include testing of all parameters.



POST OFFICE BOX 655303 • DALLAS, TEXAS 75265

Copyright © 2002, Texas Instruments Incorporated

THS5671A
14-BIT, 125 MSPS, CommsDAC™
DIGITAL-TO-ANALOG CONVERTER

SLAS201A – DECEMBER 1999 – REVISED SEPTEMBER 2002

description (continued)

The THS5671A is available in both a 28-pin SOIC and TSSOP package. The device is characterized for operation over the industrial temperature range of -40°C to 85°C .

AVAILABLE OPTIONS

T _A	PACKAGE	
	28-TSSOP (PW)	28-SOIC (DW)
-40°C to 85°C	THS5671AIPW	THS5671AIDW

functional block diagram

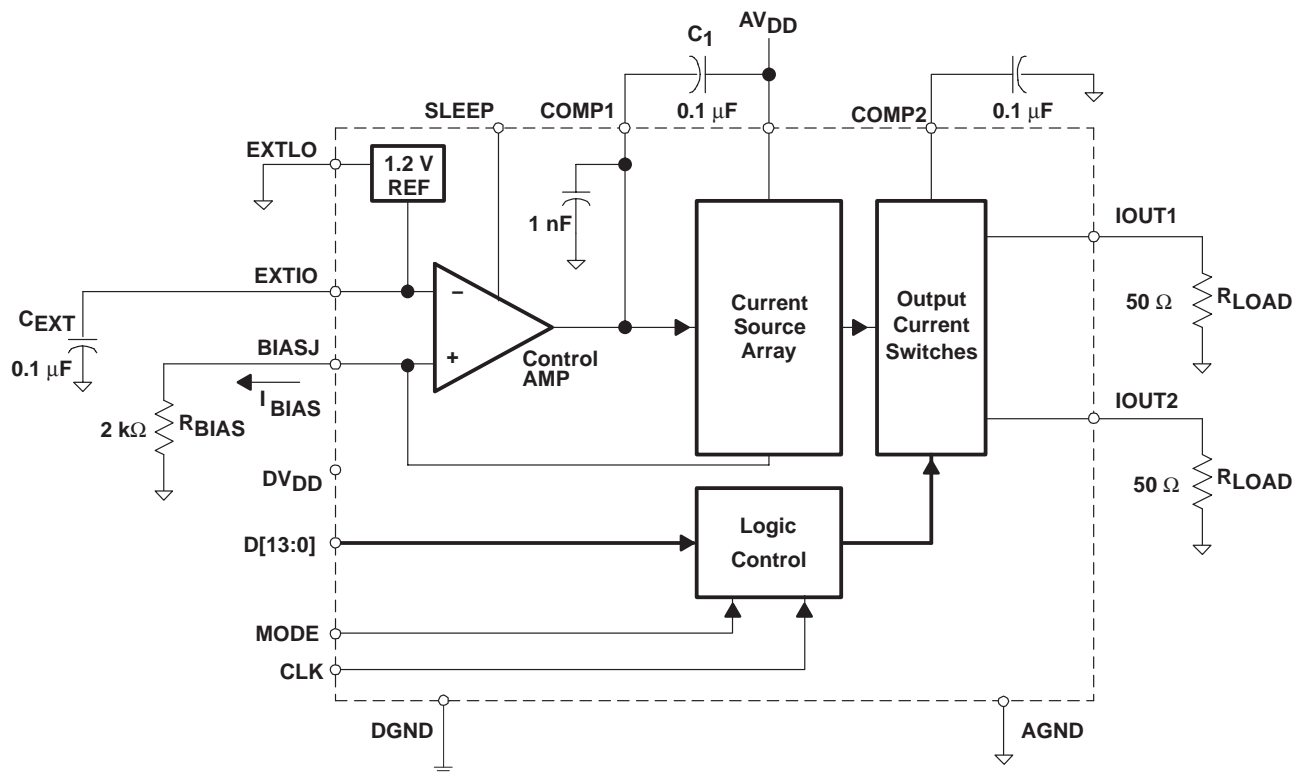

Terminal Functions

TERMINAL NAME	NO.	I/O	DESCRIPTION
AGND	20	I	Analog ground return for the internal analog circuitry
AV _{DD}	24	I	Positive analog supply voltage (4.5 V to 5.5 V)
BIASJ	18	O	Full-scale output current bias
CLK	28	I	External clock input. Input data latched on rising edge of the clock.
COMP1	19	I	Compensation and decoupling node, requires a 0.1 μF capacitor to AV _{DD} .
COMP2	23	I	Internal bias node, requires a 0.1 μF decoupling capacitor to AGND.
D[13:0]	[1:14]	I	Data bits 0 through 13. D13 is most significant data bit (MSB), D0 is least significant data bit (LSB).
DGND	26	I	Digital ground return for the internal digital logic circuitry
DV _{DD}	27	I	Positive digital supply voltage (3 V to 5.5 V)
EXTIO	17	I/O	Used as external reference input when internal reference is disabled (i.e., EXTLO = AV _{DD}). Used as internal reference output when EXTLO = AGND, requires a 0.1 μF decoupling capacitor to AGND when used as reference output.
EXTLO	16	O	Internal reference ground. Connect to AV _{DD} to disable the internal reference source.
IOUT1	22	O	DAC current output. Full scale when all input bits are set 1
IOUT2	21	O	Complementary DAC current output. Full scale when all input bits are 0
MODE	25	I	Mode select. Internal pulldown. Mode 0 is selected if this pin is left floating or connected to DGND. See timing diagram.
SLEEP	15	I	Asynchronous hardware power down input. Active high. Internal pulldown. Requires 5 μs to power down but 3 ms to power up.

absolute maximum ratings over operating free-air temperature (unless otherwise noted)†

Supply voltage range, AV _{DD} (see Note 1)	–0.3 V to 6.5 V
DV _{DD} (see Note 2)	–0.3 V to 6.5 V
Voltage between AGND and DGND	–0.3 V to 0.5 V
Supply voltage range, AV _{DD} to DV _{DD}	–6.5 V to 6.5 V
CLK, SLEEP, MODE (see Note 2)	–0.3 V to DV _{DD} + 0.3 V
Digital input D13–D0 (see Note 2)	–0.3 V to DV _{DD} + 0.3 V
IOUT1, IOUT2 (see Note 1)	–1 V to AV _{DD} + 0.3 V
COMP1, COMP2 (see Note 1)	–0.3 V to AV _{DD} + 0.3 V
EXTIO, BIASJ (see Note 1)	–0.3 V to AV _{DD} + 0.3 V
EXTLO (see Note 1)	–0.3 V to 0.3 V
Peak input current (any input)	20 mA
Peak total input current (all inputs)	–30 mA
Operating free-air temperature range, T _A : THS5671AI	–40°C to 85°C
Storage temperature range	–65°C to 150°C
Lead temperature 1,6 mm (1/16 inch) from the case for 10 seconds	260°C

† Stresses beyond those listed under “absolute maximum ratings” may cause permanent damage to the device. These are stress ratings only, and functional operation of the device at these or any other conditions beyond those indicated under “recommended operating conditions” is not implied. Exposure to absolute-maximum-rated conditions for extended periods may affect device reliability.

- NOTES: 1. Measured with respect to AGND.
 2. Measured with respect to DGND.

THS5671A
14-BIT, 125 MSPS, CommsDAC™
DIGITAL-TO-ANALOG CONVERTER

SLAS201A – DECEMBER 1999 – REVISED SEPTEMBER 2002

electrical characteristics over recommended operating free-air temperature range, $AV_{DD} = 5\text{ V}$, $DV_{DD} = 5\text{ V}$, $I_{OUTFS} = 20\text{ mA}$ (unless otherwise noted)

dc specifications

PARAMETER		TEST CONDITIONS	MIN	TYP	MAX	UNIT
Resolution			14			Bits
DC accuracy†						
INL	Integral nonlinearity	$T_A = -40^\circ\text{C}$ to 85°C	-7	± 2.5	7	LSB
DNL	Differential nonlinearity		-3.5	± 2	3.5	LSB
Monotonicity		At 11-bit level	Monotonic			
Analog output						
Offset error			0.02			%FSR
Gain error		Without internal reference	2.3			%FSR
		With internal reference	1.3			
Full scale output current‡			2		20	mA
Output compliance range		$AV_{DD} = 5\text{ V}$, $I_{OUTFS} = 20\text{ mA}$	-1		1.25	V
Output resistance			300			k Ω
Output capacitance			5			pF
Reference output						
Reference voltage			1.18	1.22	1.32	V
Reference output current§			100			nA
Reference input						
V _{EXTIO}	Input voltage range		0.1		1.25	V
Input resistance			1			M Ω
Small signal bandwidth¶		Without C_{COMP1}	1.3			MHz
Input capacitance			100			pF
Temperature coefficients						
Offset drift			0			ppm of FSR/ $^\circ\text{C}$
Gain drift		Without internal reference	± 40			
		With internal reference	± 120			
Reference voltage drift			± 35			
Power supply						
AV_{DD}	Analog supply voltage		4.5	5	5.5	V
DV_{DD}	Digital supply voltage		3		5.5	V
I_{AVDD}	Analog supply current		25 30			mA
	Sleep mode supply current	Sleep mode	3 5			mA
I_{DVDD}	Digital supply current#		5 6			mA
Power dissipation		$AV_{DD} = 5\text{ V}$, $DV_{DD} = 5\text{ V}$, $I_{OUTFS} = 20\text{ mA}$	175			mW
AV_{DD}	Power supply rejection ratio		± 0.4			%FSR/V
DV_{DD}			± 0.025			
Operating range			-40		85	$^\circ\text{C}$

† Measured at IOUT1 in virtual ground configuration.

‡ Nominal full-scale current I_{OUTFS} equals 32X the IBIAS current.

§ Use an external buffer amplifier with high impedance input to drive any external load.

¶ Reference bandwidth is a function of external cap at COMP1 pin and signal level.

Measured at $f_{CLK} = 50\text{ MSPS}$ and $f_{OUT} = 1\text{ MHz}$.

|| Measured for $50\ \Omega$ R_{LOAD} at IOUT1 and IOUT2, $f_{CLK} = 50\text{ MSPS}$ and $f_{OUT} = 20\text{ MHz}$.

Specifications subject to change



electrical characteristics over recommended operating free-air temperature range, $V_{DD} = 5\text{ V}$, $DV_{DD} = 5\text{ V}$, $I_{OUTFS} = 20\text{ mA}$, differential transformer coupled output, $50\ \Omega$ doubly terminated load (unless otherwise noted)

ac specifications

PARAMETER		TEST CONDITIONS	MIN	TYP	MAX	UNIT
Analog output						
f_{CLK}	Maximum output update rate	$DV_{DD} = 4.5\text{ V to }5.5\text{ V}$	100	125		MSPS
		$DV_{DD} = 3\text{ V to }3.6\text{ V}$	70	100		
$t_s(DAC)$	Output settling time to 0.1%†			35		ns
t_{pd}	Output propagation delay			1		ns
GE	Glitch energy‡	Worst case LSB transition (code 8191 – code 8192)		5		pV-s
$t_r(I_{OUT})$	Output rise time 10% to 90%†			1		ns
$t_f(I_{OUT})$	Output fall time 90% to 10%†			1		ns
Output noise		$I_{OUTFS} = 20\text{ mA}$		15		$\text{pA}/\sqrt{\text{HZ}}$
		$I_{OUTFS} = 2\text{ mA}$		10		
AC linearity§						
THD	Total harmonic distortion	$f_{CLK} = 25\text{ MSPS}, f_{OUT} = 1\text{ MHz}, T_A = 25^\circ\text{C}$		-74		dBc
		$f_{CLK} = 50\text{ MSPS}, f_{OUT} = 1\text{ MHz}, T_A = -40^\circ\text{C to }85^\circ\text{C}$		-73	-66	
		$f_{CLK} = 50\text{ MSPS}, f_{OUT} = 2\text{ MHz}, T_A = 25^\circ\text{C}$		-71		
		$f_{CLK} = 100\text{ MSPS}, f_{OUT} = 2\text{ MHz}, T_A = 25^\circ\text{C}$		-71		
SFDR	Spurious free dynamic range to Nyquist	$f_{CLK} = 25\text{ MSPS}, f_{OUT} = 1\text{ MHz}, T_A = 25^\circ\text{C}$		82		dBc
		$f_{CLK} = 50\text{ MSPS}, f_{OUT} = 1\text{ MHz}, T_A = -40^\circ\text{C to }85^\circ\text{C}$		68		
		$f_{CLK} = 50\text{ MSPS}, f_{OUT} = 1\text{ MHz}, T_A = 25^\circ\text{C}$		82		
		$f_{CLK} = 50\text{ MSPS}, f_{OUT} = 2.51\text{ MHz}, T_A = 25^\circ\text{C}$		75		
		$f_{CLK} = 50\text{ MSPS}, f_{OUT} = 5.02\text{ MHz}, T_A = 25^\circ\text{C}$		74		
		$f_{CLK} = 50\text{ MSPS}, f_{OUT} = 20.2\text{ MHz}, T_A = 25^\circ\text{C}$		57		
		$f_{CLK} = 100\text{ MSPS}, f_{OUT} = 5.04\text{ MHz}, T_A = 25^\circ\text{C}$		70		
	Spurious free dynamic range within a window	$f_{CLK} = 100\text{ MSPS}, f_{OUT} = 20.2\text{ MHz}, T_A = 25^\circ\text{C}$		66		dBc
		$f_{CLK} = 100\text{ MSPS}, f_{OUT} = 40.4\text{ MHz}, T_A = 25^\circ\text{C}$		63		dBc
		$f_{CLK} = 50\text{ MSPS}, f_{OUT} = 1\text{ MHz}, T_A = 25^\circ\text{C}, 1\text{ MHz span}$		90		dBc
$f_{CLK} = 50\text{ MSPS}, f_{OUT} = 5.02\text{ MHz}, 2\text{ MHz span}$		89				
	$f_{CLK} = 100\text{ MSPS}, f_{OUT} = 5.04\text{ MHz}, 4\text{ MHz span}$		89			

† Measured single ended into $50\ \Omega$ load at I_{OUT1} .

‡ Single-ended output I_{OUT1} , $50\ \Omega$ doubly terminated load.

§ Measured with a 50%/50% duty cycle (high/low percentage of the clock). Optimum ac linearity is obtained when limiting the duty cycle to a range from 45%/55% to 55%/45%.

THS5671A
14-BIT, 125 MSPS, CommsDAC™
DIGITAL-TO-ANALOG CONVERTER

SLAS201A – DECEMBER 1999 – REVISED SEPTEMBER 2002

electrical characteristics over recommended operating free-air temperature range, $AV_{DD} = 5\text{ V}$, $DV_{DD} = 5\text{ V}$, $IO_{UTFS} = 20\text{ mA}$ (unless otherwise noted)

digital specifications

PARAMETER		TEST CONDITIONS	MIN	TYP	MAX	UNIT
Interface						
V_{IH}	High-level input voltage	$DV_{DD} = 5\text{ V}$	3.5	5		V
		$DV_{DD} = 3.3\text{ V}$	2.1	3.3		
V_{IL}	Low-level input voltage	$DV_{DD} = 5\text{ V}$		0	1.3	V
		$DV_{DD} = 3.3\text{ V}$		0	0.9	
I_{IH}	High-level input current	MODE and SLEEP	$DV_{DD} = 3\text{ V to }5.5\text{ V}$	-15	15	μA
		All other digital pins	$DV_{DD} = 3\text{ V to }5.5\text{ V}$	-10	10	
I_{IL}	Low-level input current	MODE and SLEEP	$DV_{DD} = 3\text{ V to }5.5\text{ V}$	-15	15	μA
		All other digital pins	$DV_{DD} = 3\text{ V to }5.5\text{ V}$	-10	10	
C_I	Input capacitance		1		5	pF
Timing						
$t_{su(D)}$	Input setup time		1			ns
$t_h(D)$	Input hold time		1			ns
$t_w(LPH)$	Input latch pulse high time		4			ns
$t_d(D)$	Digital delay time				1	clk

Specifications subject to change



TYPICAL CHARACTERISTICS†

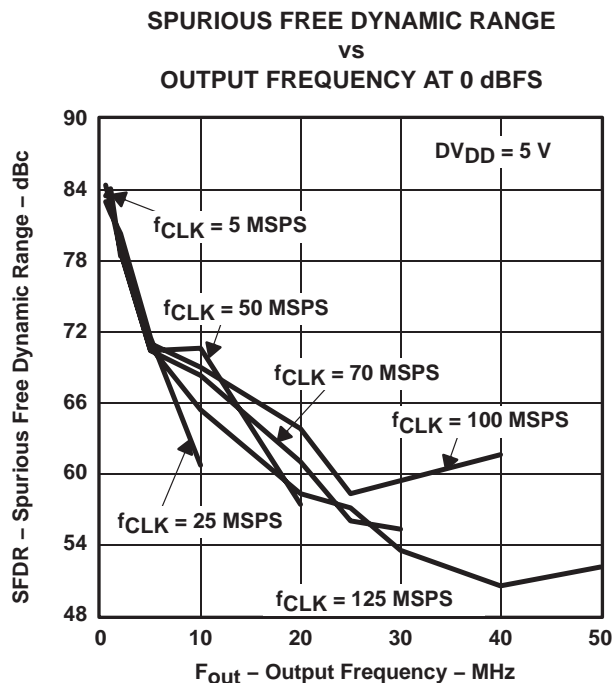

Figure 1

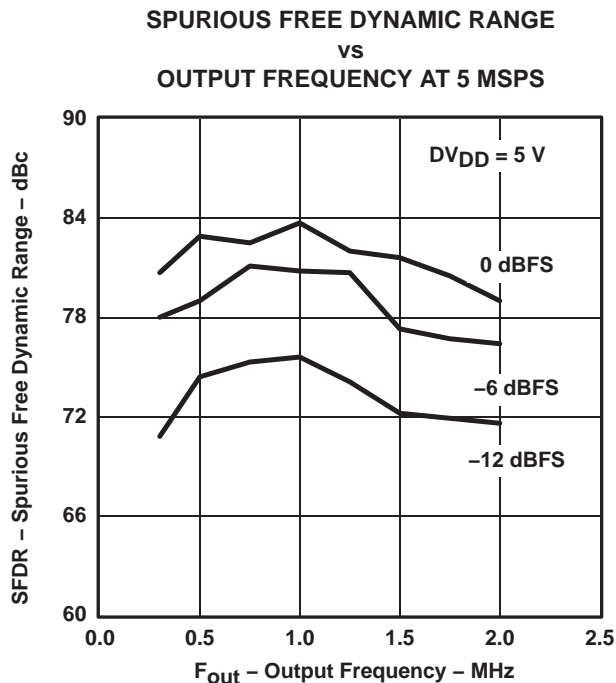

Figure 2

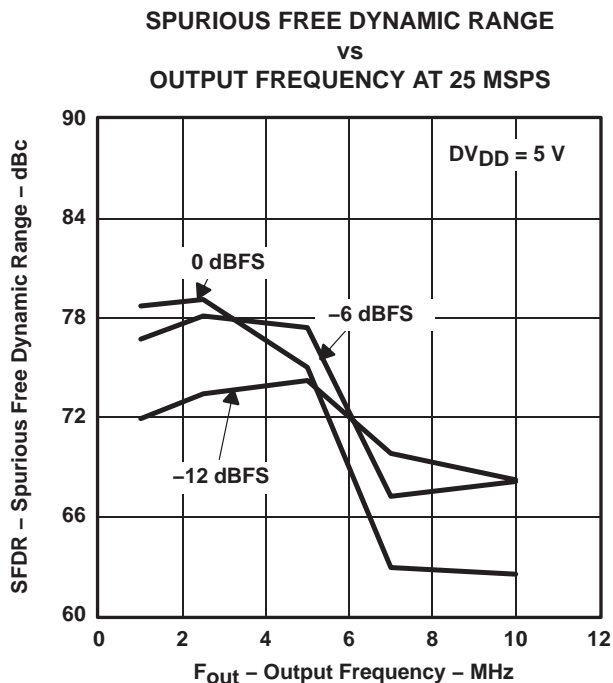

Figure 3

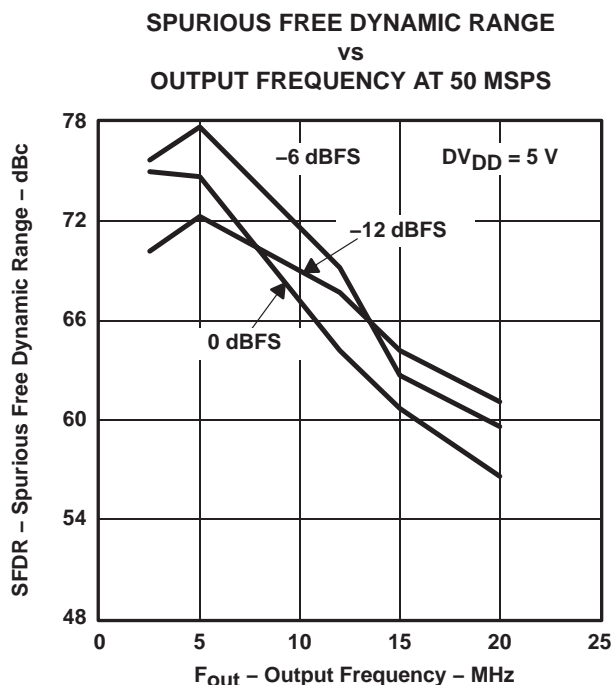

Figure 4

† $A_{V_{DD}} = 5\text{ V}$, $I_{OUTFS} = 20\text{ mA}$, differential transformer coupled output, $50\ \Omega$ doubly terminated load, $T_A = 25^\circ\text{C}$ (unless otherwise noted.)

TYPICAL CHARACTERISTICS†

**SPURIOUS FREE DYNAMIC RANGE
vs
OUTPUT FREQUENCY AT 70 MSPS**

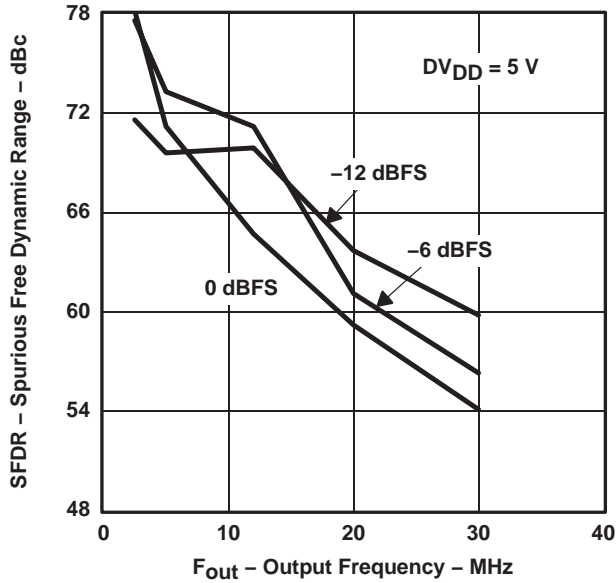

Figure 5

**SPURIOUS FREE DYNAMIC RANGE
vs
OUTPUT FREQUENCY AT 100 MSPS**

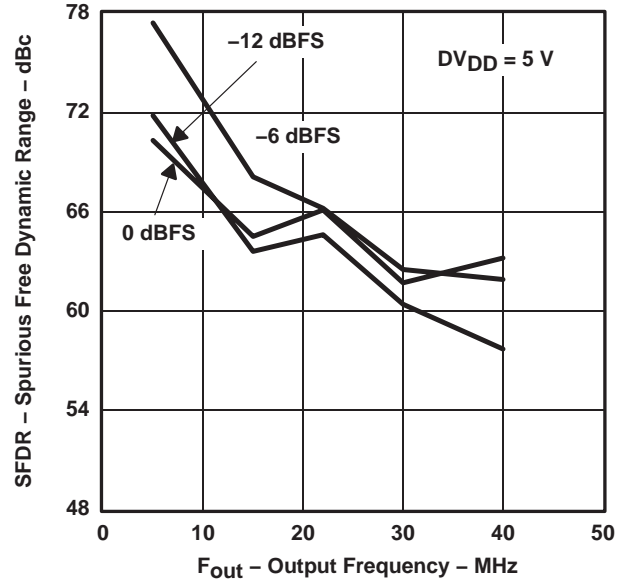

Figure 6

**SPURIOUS FREE DYNAMIC RANGE
vs
OUTPUT FREQUENCY AT 125 MSPS**

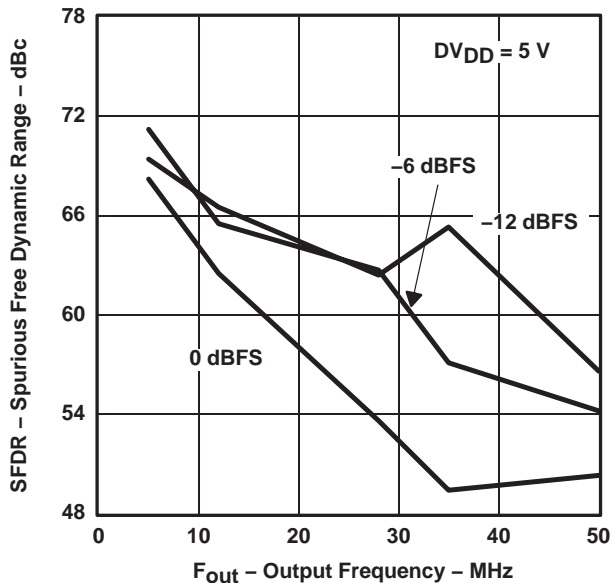

Figure 7

**SPURIOUS FREE DYNAMIC RANGE
vs
OUTPUT FREQUENCY AT 0 dBFS**

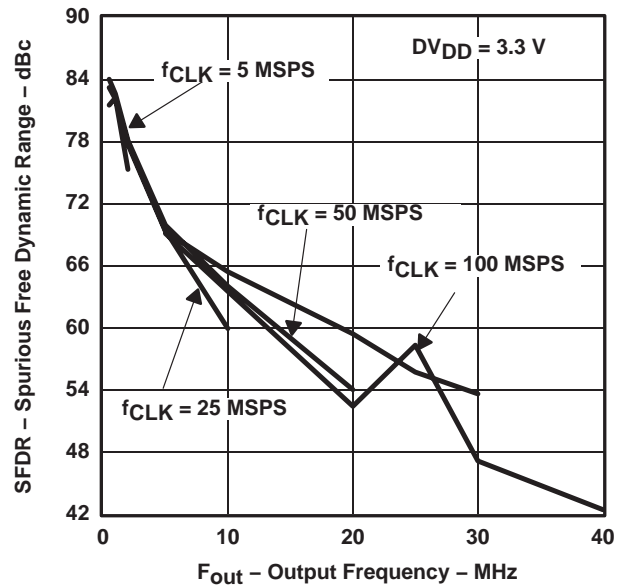

Figure 8

† AV_{DD} = 5 V, IO_{UTFS} = 20 mA, differential transformer coupled output, 50 Ω doubly terminated load, T_A = 25°C (unless otherwise noted.)

TYPICAL CHARACTERISTICS†

SPURIOUS FREE DYNAMIC RANGE
 vs
 OUTPUT FREQUENCY AT 5 MSPS

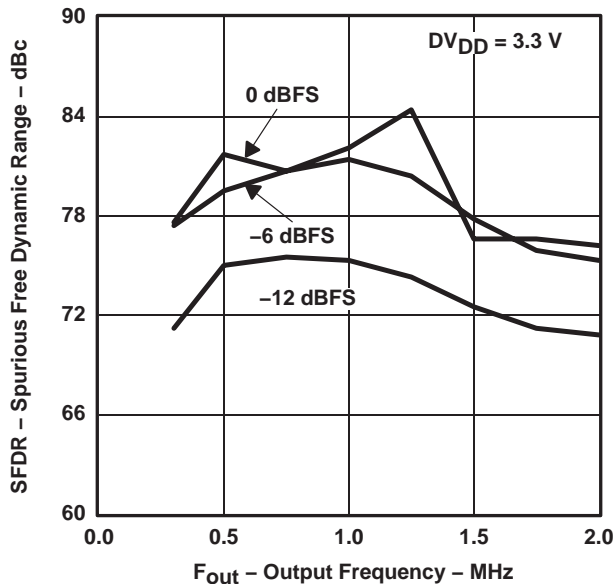

Figure 9

SPURIOUS FREE DYNAMIC RANGE
 vs
 OUTPUT FREQUENCY AT 25 MSPS

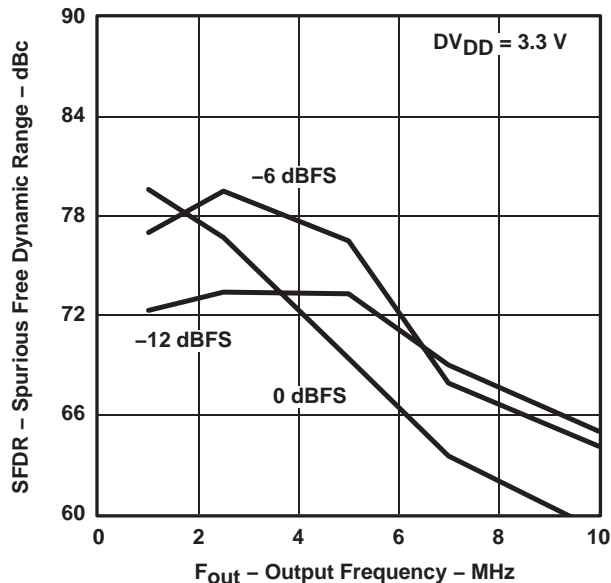

Figure 10

SPURIOUS FREE DYNAMIC RANGE
 vs
 OUTPUT FREQUENCY AT 50 MSPS

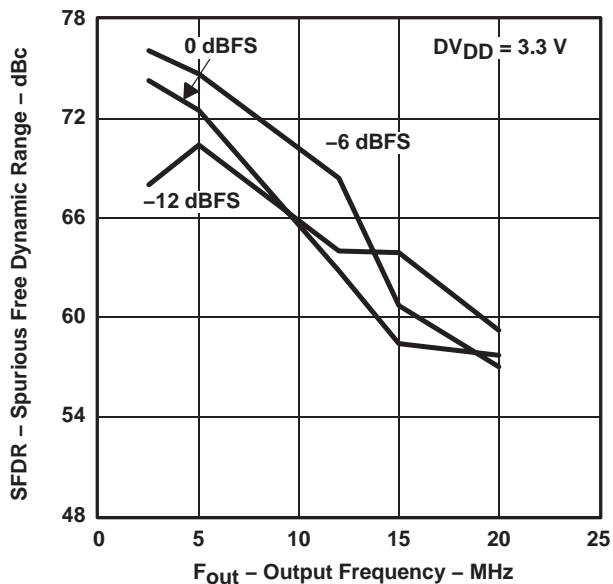

Figure 11

SPURIOUS FREE DYNAMIC RANGE
 vs
 OUTPUT FREQUENCY AT 70 MSPS

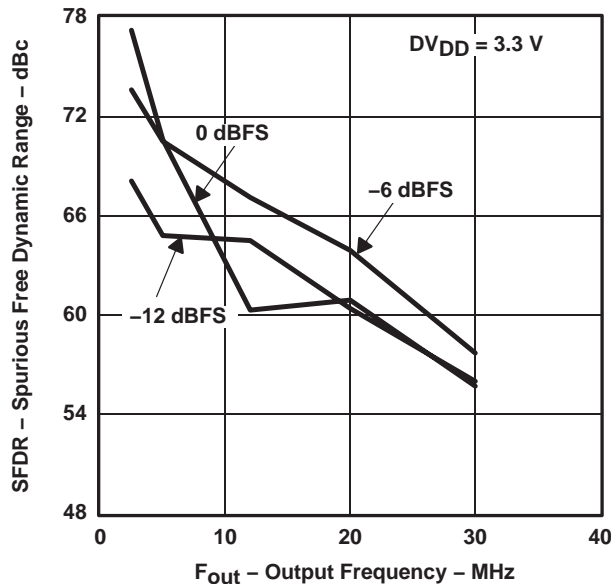

Figure 12

† $AV_{DD} = 5\text{ V}$, $I_{OUTFS} = 20\text{ mA}$, differential transformer coupled output, $50\ \Omega$ doubly terminated load, $T_A = 25^\circ\text{C}$ (unless otherwise noted.)

TYPICAL CHARACTERISTICS†

SPURIOUS FREE DYNAMIC RANGE
 vs
 A_{OUT} AT $F_{OUT} = F_{CLOCK}/11$

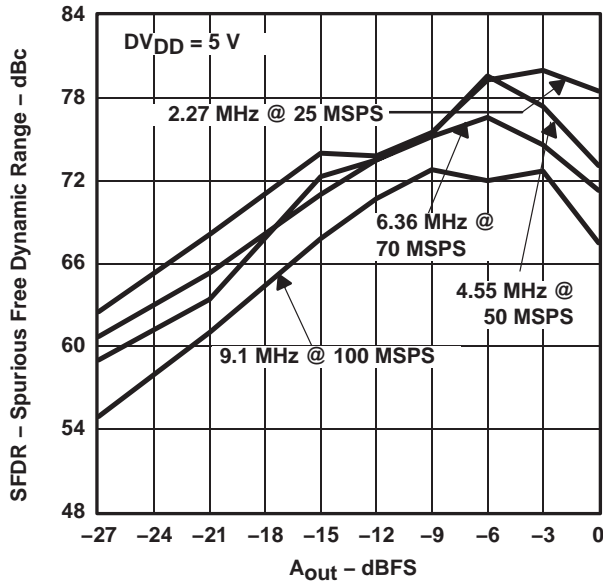

Figure 13

SPURIOUS FREE DYNAMIC RANGE
 vs
 A_{OUT} AT $F_{OUT} = F_{CLOCK}/5$

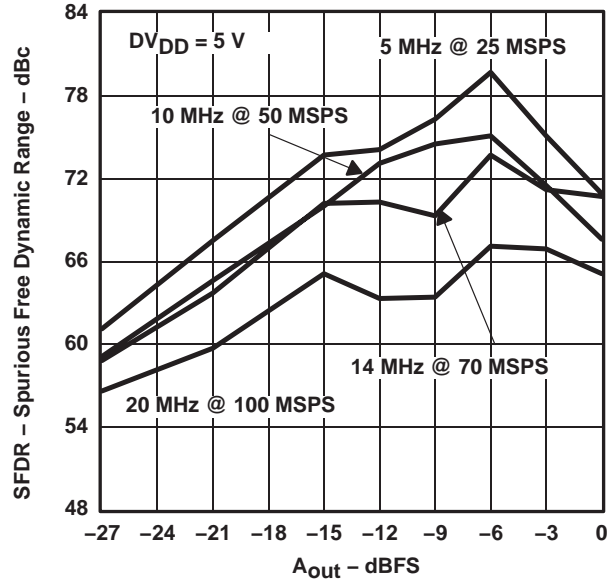

Figure 14

DUAL TONE SPURIOUS FREE DYNAMIC RANGE
 vs
 A_{OUT} AT $F_{OUT} = F_{CLOCK}/7$

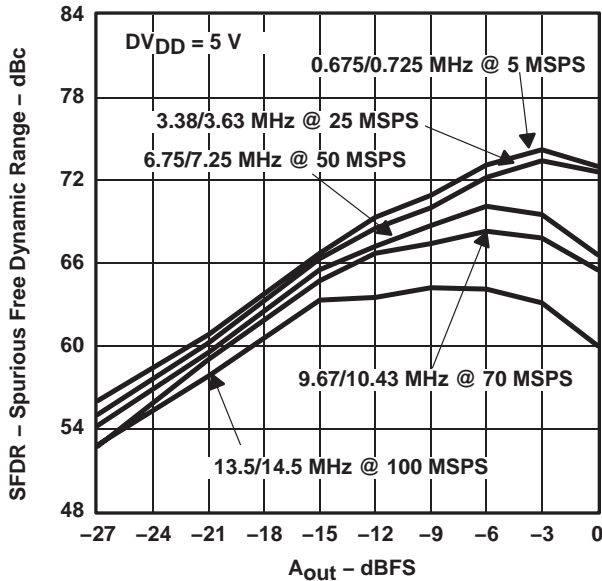

Figure 15

TOTAL HARMONIC DISTORTION
 vs
 CLOCK FREQUENCY AT $F_{OUT} = 2$ MHz

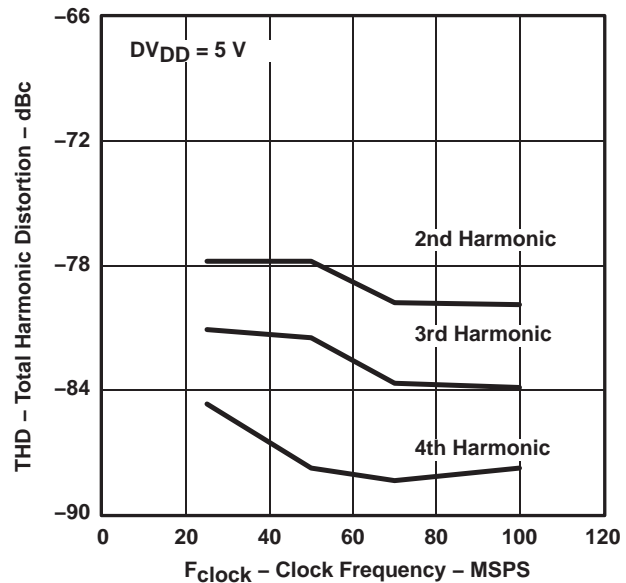

Figure 16

† $A_{V_{DD}} = 5$ V, $I_{OUT_{FS}} = 20$ mA, differential transformer coupled output, 50 Ω doubly terminated load, $T_A = 25^\circ\text{C}$ (unless otherwise noted.)

TYPICAL CHARACTERISTICS†

**SPURIOUS FREE DYNAMIC RANGE
vs
FULL-SCALE OUTPUT CURRENT AT 100 MSPS**

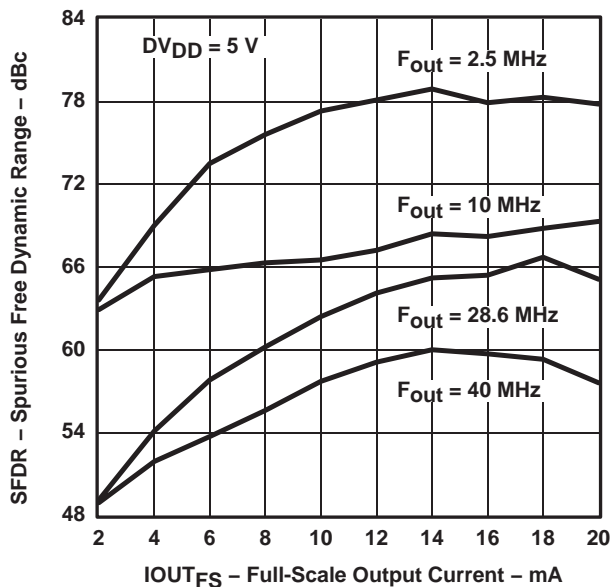

Figure 17

**SPURIOUS FREE DYNAMIC RANGE
vs
OUTPUT FREQUENCY AT 100 MSPS**

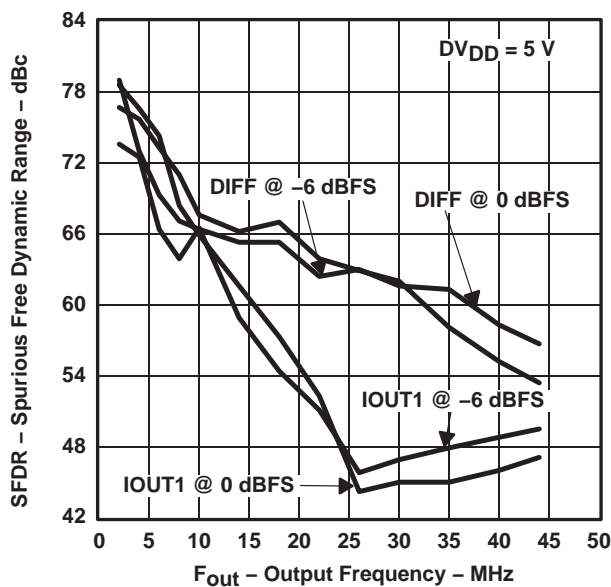

Figure 18

**SPURIOUS FREE DYNAMIC RANGE
vs
TEMPERATURE AT 70 MSPS**

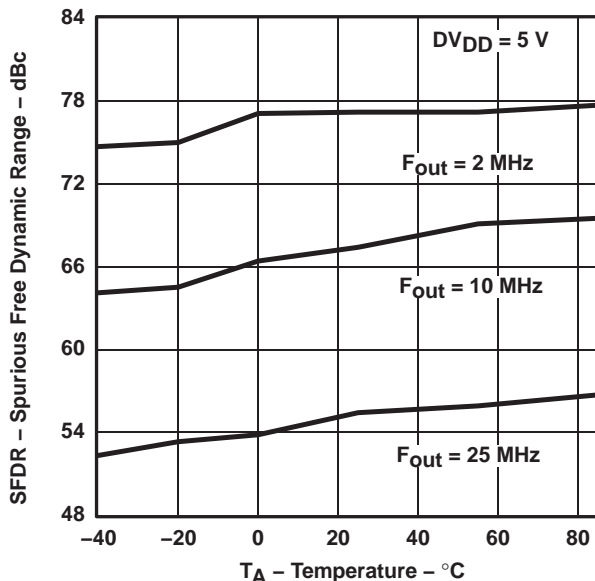

Figure 19

† $A_{V_{DD}} = 5\text{ V}$, $I_{O_{TFS}} = 20\text{ mA}$, differential transformer coupled output, $50\ \Omega$ doubly terminated load, $T_A = 25^\circ\text{C}$ (unless otherwise noted.)

TYPICAL CHARACTERISTICS†

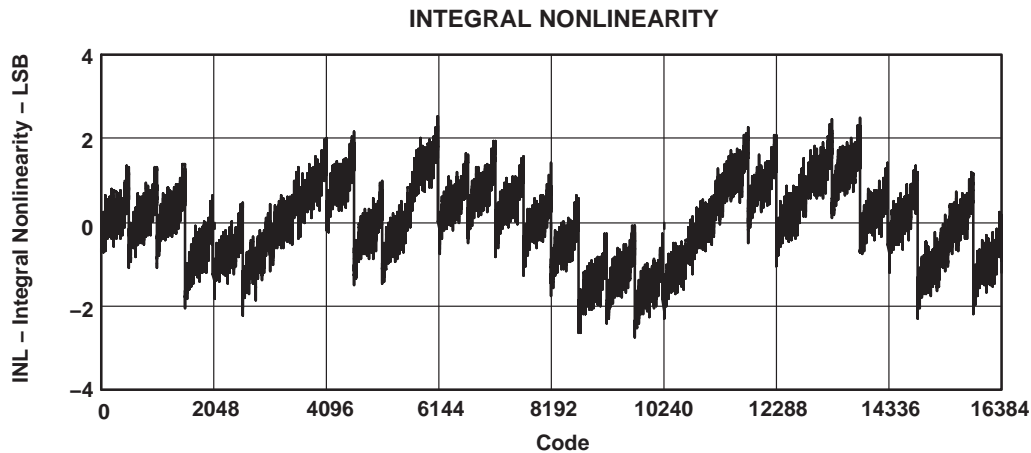

Figure 20

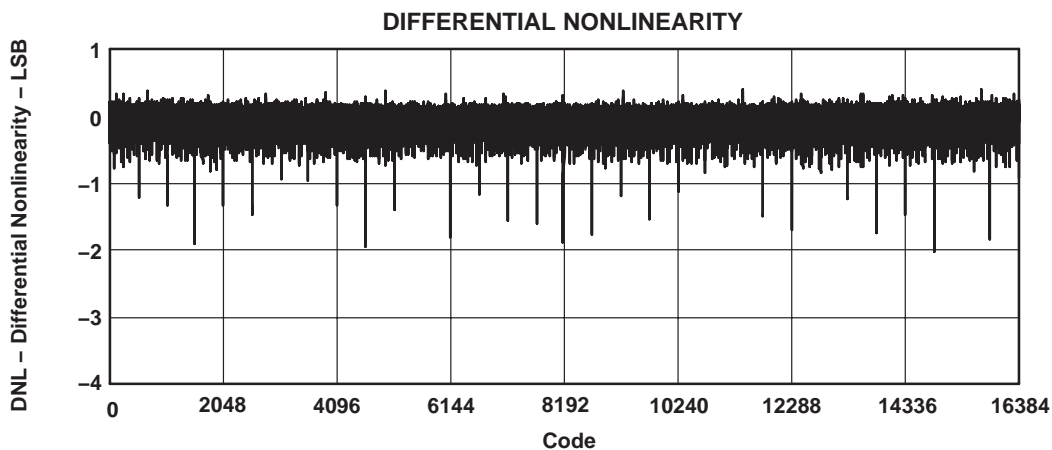

Figure 21

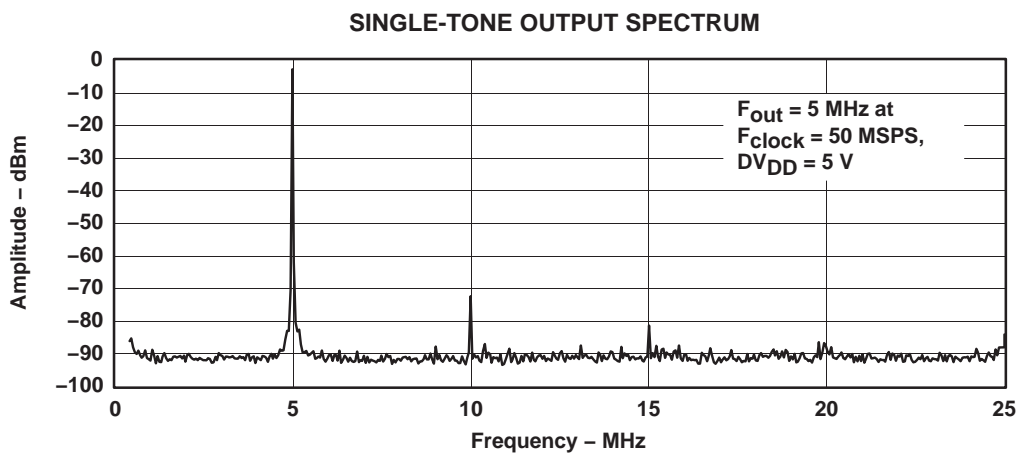

Figure 22

† AV_{DD} = 5 V, IO_{UTFS} = 20 mA, differential transformer coupled output, 50 Ω doubly terminated load, T_A = 25°C (unless otherwise noted.)

TYPICAL CHARACTERISTICS†

SINGLE-TONE OUTPUT SPECTRUM

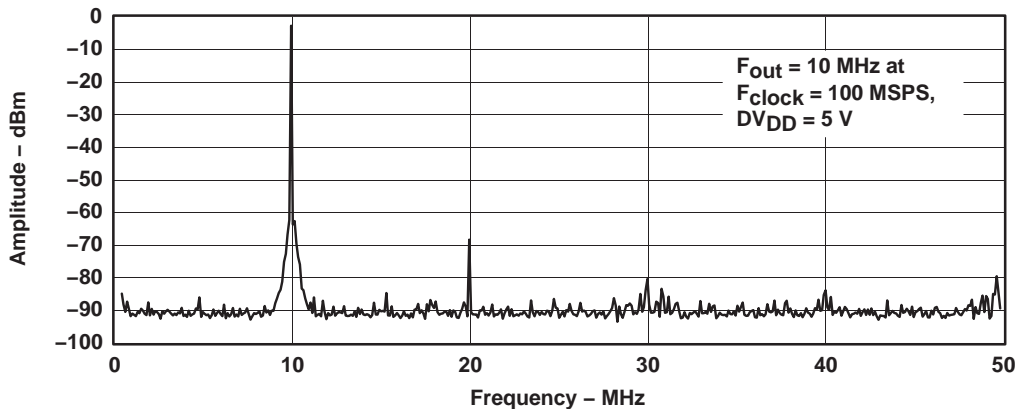

Figure 23

DUAL-TONE OUTPUT SPECTRUM

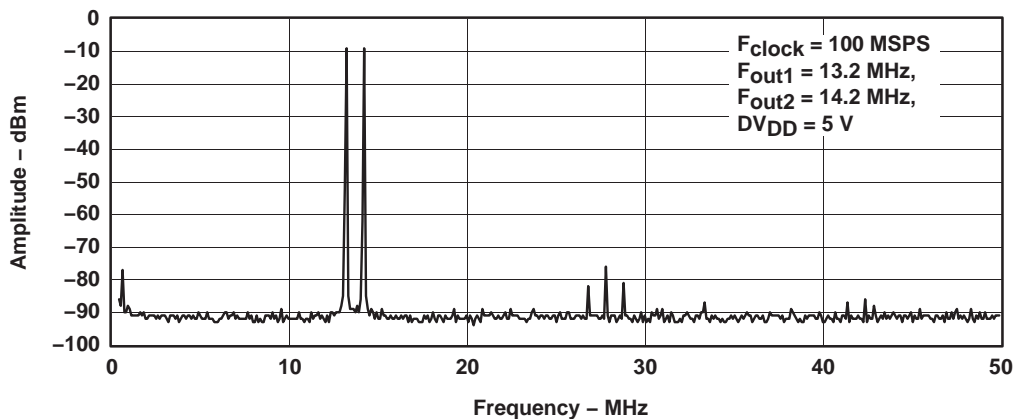

Figure 24

FOUR-TONE OUTPUT SPECTRUM

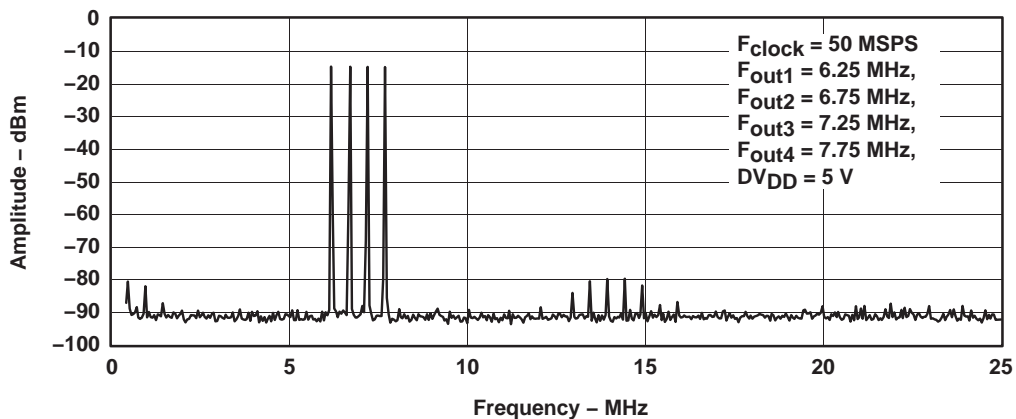

Figure 25

† $AV_{DD} = 5 \text{ V}$, $I_{OUTFS} = 20 \text{ mA}$, differential transformer coupled output, 50 Ω doubly terminated load, $T_A = 25^\circ\text{C}$ (unless otherwise noted.)

TYPICAL CHARACTERISTICS†

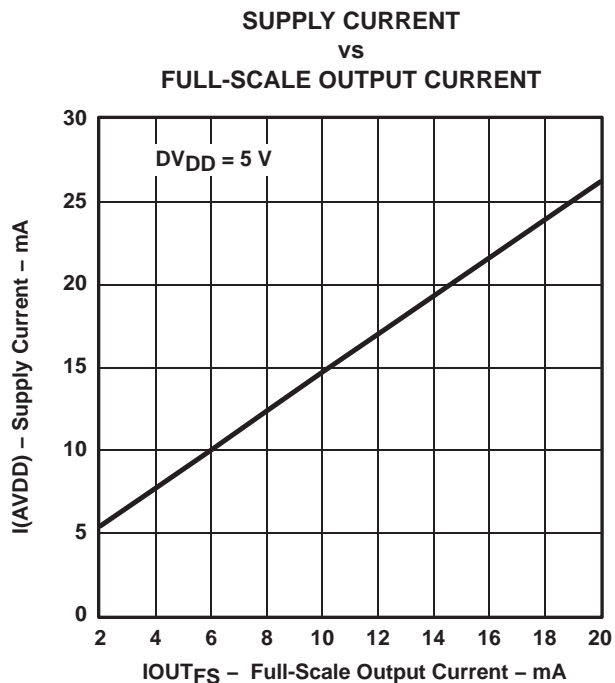

Figure 26

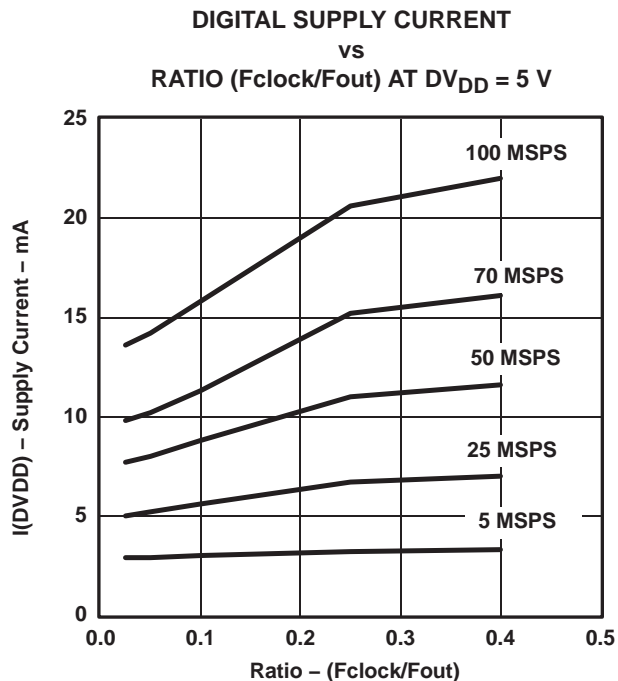

Figure 27

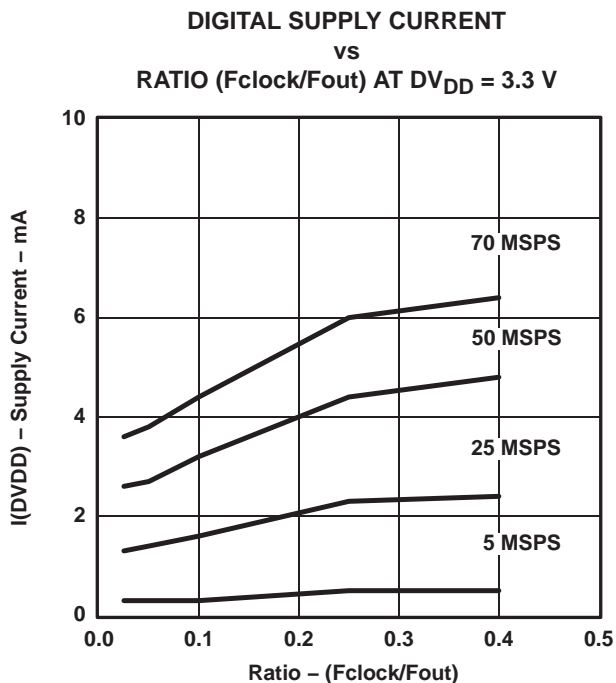

Figure 28

† AV_{DD} = 5 V, IOUT_{FS} = 20 mA, differential transformer coupled output, 50 Ω doubly terminated load, T_A = 25°C (unless otherwise noted.)

APPLICATION INFORMATION

The THS5671A architecture is based on current steering, combining high update rates with low power consumption. The CMOS device consists of a segmented array of PMOS transistor current sources, which are capable of delivering a full-scale current up to 20 mA. High-speed differential current switches direct the current of each current source to either one of the output nodes, IOUT1 or IOUT2. The complementary output currents thus enable differential operation, canceling out common mode noise sources (on-chip and PCB noise), dc offsets, even order distortion components, and increases signal output power by a factor of two. Major advantages of the segmented architecture are minimum glitch energy, excellent DNL, and very good dynamic performance. The DAC's high output impedance of >300 k Ω and fast switching result in excellent dynamic linearity (spurious free dynamic range SFDR).

The full-scale output current is set using an external resistor R_{BIAS} in combination with an on-chip bandgap voltage reference source (1.2 V) and control amplifier. The current I_{BIAS} through resistor R_{BIAS} is mirrored internally to provide a full-scale output current equal to 32 times I_{BIAS} . The full-scale current can be adjusted from 20 mA down to 2 mA.

data interface and timing

The THS5671A comprises separate analog and digital supplies, i.e. AV_{DD} and DV_{DD} . The digital supply voltage can be set from 5.5 V down to 3 V, thus enabling flexible interfacing with external logic. The THS5671A provides two operating modes, as shown in Table 1. Mode 0 (mode pin connected to DGND) supports a straight binary input data word format, whereas mode 1 (mode pin connected to DV_{DD}) sets a twos complement input configuration.

Figure 29 shows the timing diagram. Internal edge-triggered flip-flops latch the input word on the rising edge of the input clock. The THS5671A provides for minimum setup and hold times (> 1 ns), allowing for noncritical external interface timing. Conversion latency is one clock cycle for both modes. The clock duty cycle can be chosen arbitrarily under the timing constraints listed in the digital specifications table. However, a 50% duty cycle will give optimum dynamic performance. Figure 30 shows a schematic of the equivalent digital inputs of the THS5671A, valid for pins D13–D0, SLEEP, and CLK. The digital inputs are CMOS-compatible with logic thresholds of $DV_{DD}/2 \pm 20\%$. Since the THS5671A is capable of being updated up to 125 MSPS, the quality of the clock and data input signals are important in achieving the optimum performance. The drivers of the digital data interface circuitry should be specified to meet the minimum setup and hold times of the THS5671A, as well as its required min/max input logic level thresholds. Typically, the selection of the slowest logic family that satisfies the above conditions will result in the lowest data feed-through and noise. Additionally, operating the THS5671A with reduced logic swings and a corresponding digital supply (DV_{DD}) will reduce data feed-through. Note that the update rate is limited to 70 MSPS for a digital supply voltage DV_{DD} of 3 V to 3.6 V.

APPLICATION INFORMATION

data interface and timing (continued)

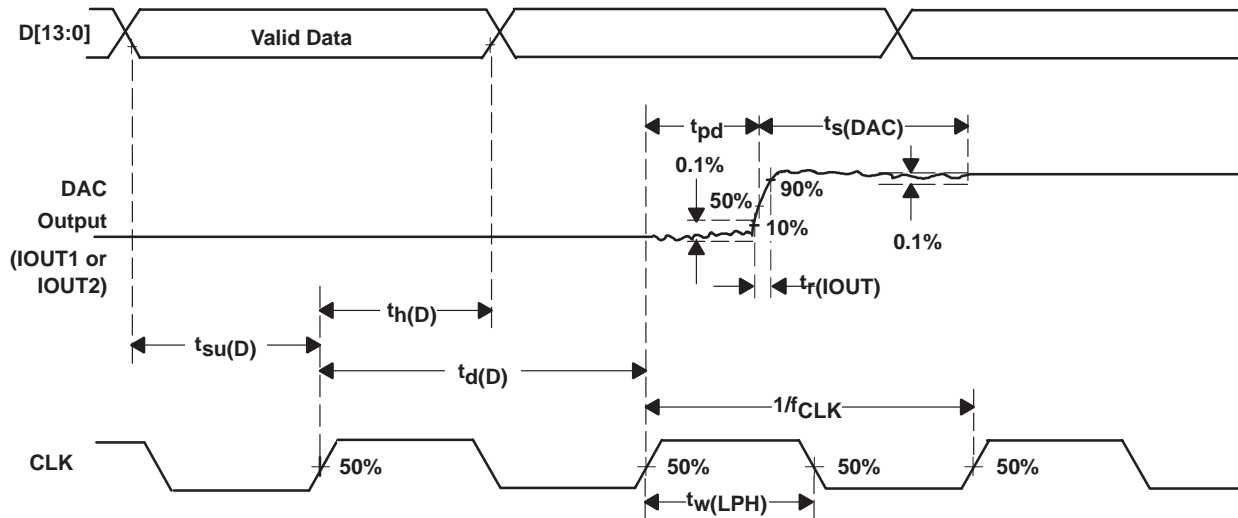

Figure 29. Timing Diagram

Table 1. Input Interface Modes

FUNCTION/MODE	MODE 0	MODE 1
	MODE PIN CONNECTED TO DGND	MODE PIN CONNECTED TO DVDD
Input code format	Binary	Twos complement

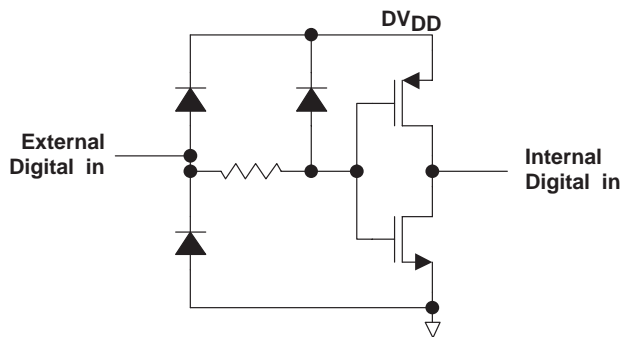

Figure 30. Digital Equivalent Input

APPLICATION INFORMATION

DAC transfer function

The THS5671A delivers complementary output currents IOUT1 and IOUT2. Output current IOUT1 equals the approximate full-scale output current when all input bits are set high in mode 0 (straight binary input), i.e. the binary input word has the decimal representation 16383. For mode 1, the MSB is inverted (twos complement input format). Full-scale output current will flow through terminal IOUT2 when all input bits are set low (mode 0, straight binary input). The relation between IOUT1 and IOUT2 can thus be expressed as:

$$IOUT1 = IOUT_{FS} - IOUT2$$

where IOUT_{FS} is the full-scale output current. The output currents can be expressed as:

$$IOUT1 = IOUT_{FS} \times \frac{CODE}{16384}$$

$$IOUT2 = IOUT_{FS} \times \frac{(16383 - CODE)}{16384}$$

where CODE is the decimal representation of the DAC data input word. Output currents IOUT1 and IOUT2 drive resistor loads R_{LOAD} or a transformer with equivalent input load resistance R_{LOAD}. This would translate into single-ended voltages VOUT1 and VOUT2 at terminal IOUT1 and IOUT2, respectively, of:

$$VOUT1 = IOUT1 \times R_{LOAD} = \frac{CODE}{16384} \times IOUT_{FS} \times R_{LOAD}$$

$$VOUT2 = IOUT2 \times R_{LOAD} = \frac{(16383 - CODE)}{16384} \times IOUT_{FS} \times R_{LOAD}$$

The differential output voltage VOUT_{DIFF} can thus be expressed as:

$$VOUT_{DIFF} = VOUT1 - VOUT2 = \frac{(2CODE - 16383)}{16384} \times IOUT_{FS} \times R_{LOAD}$$

The latter equation shows that applying the differential output will result in doubling of the signal power delivered to the load. Since the output currents of IOUT1 and IOUT2 are complementary, they become additive when processed differentially. Care should be taken not to exceed the compliance voltages at node IOUT1 and IOUT2, which would lead to increased signal distortion.

APPLICATION INFORMATION

reference operation

The THS5671A comprises a bandgap reference and control amplifier for biasing the full-scale output current. The full-scale output current is set by applying an external resistor R_{BIAS} . The bias current I_{BIAS} through resistor R_{BIAS} is defined by the on-chip bandgap reference voltage and control amplifier. The full-scale output current equals 32 times this bias current. The full-scale output current $I_{OUT_{FS}}$ can thus be expressed as:

$$I_{OUT_{FS}} = 32 \times I_{BIAS} = \frac{32 \times V_{EXTIO}}{R_{BIAS}}$$

where V_{EXTIO} is the voltage at terminal EXTIO. The bandgap reference voltage delivers an accurate voltage of 1.2 V. This reference is active when terminal EXTLO is connected to AGND. An external decoupling capacitor C_{EXT} of 0.1 μ F should be connected externally to terminal EXTIO for compensation. The bandgap reference can additionally be used for external reference operation. In that case, an external buffer with high impedance input should be applied in order to limit the bandgap load current to a maximum of 100 nA. The internal reference can be disabled and overridden by an external reference by connecting EXTLO to AVDD. Capacitor C_{EXT} may hence be omitted. Terminal EXTIO thus serves as either input or output node.

The full-scale output current can be adjusted from 20 mA down to 2 mA by varying resistor R_{BIAS} or changing the externally applied reference voltage. The internal control amplifier has a wide input range, supporting the full-scale output current range of 20 dB. The bandwidth of the internal control amplifier is defined by the internal 1 nF compensation capacitor at pin COMP1 and the external compensation capacitor C1. The relatively weak internal control amplifier may be overridden by an externally applied amplifier with sufficient drive for the internal 1 nF load, as shown in Figure 31. This provides the user with more flexibility and higher bandwidths, which are specifically attractive for gain control and multiplying DAC applications. Pin SLEEP should be connected to AGND or left disconnected when an external control amplifier is used.

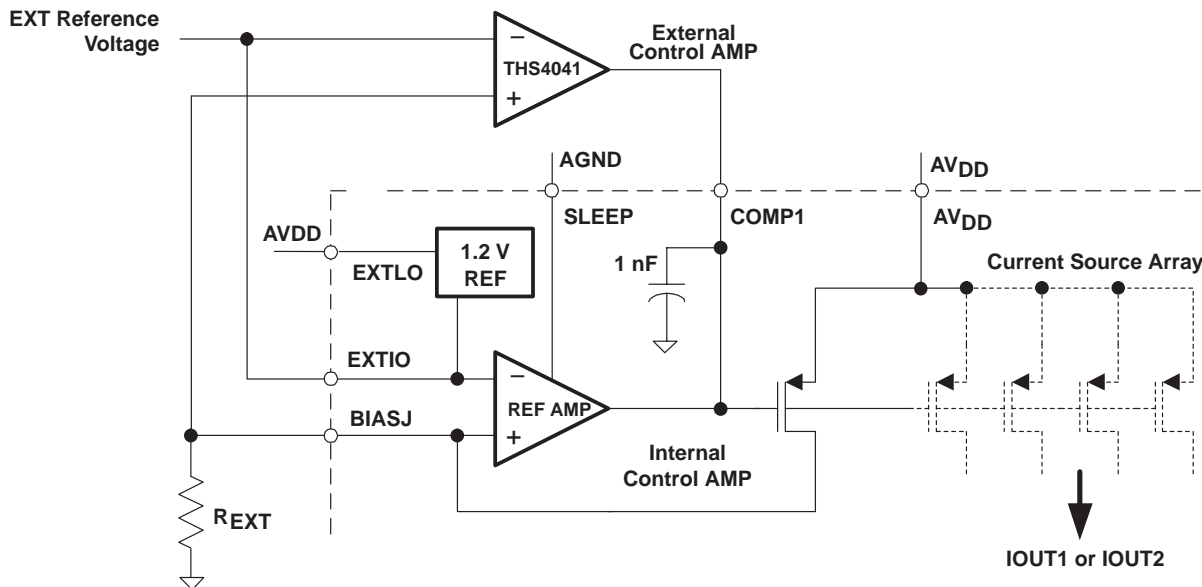

Figure 31. Bypassing the Internal Reference and Control Amplifier

APPLICATION INFORMATION

analog current outputs

Figure 32 shows a simplified schematic of the current source array output with corresponding switches. Differential PMOS switches direct the current of each individual PMOS current source to either the positive output node IOUT1 or its complementary negative output node IOUT2. The output impedance is determined by the stack of the current sources and differential switches, and is typically >300 kΩ in parallel with an output capacitance of 5 pF.

Output nodes IOUT1 and IOUT2 have a negative compliance voltage of -1 V, determined by the CMOS process. Beyond this value, transistor breakdown may occur, resulting in reduced reliability of the THS5671A device. The positive output compliance depends on the full-scale output current I_{OUTFS} and positive supply voltage AV_{DD} . The positive output compliance equals 1.25 V for $AV_{DD} = 5$ V and $I_{OUTFS} = 20$ mA. Exceeding the positive compliance voltage adversely affects distortion performance and integral nonlinearity. The optimum distortion performance for a single-ended or differential output is achieved when the maximum full-scale signal at IOUT1 and IOUT2 does not exceed 0.5 V (e.g. when applying a 50 Ω doubly terminated load for 20 mA full-scale output current). Applications requiring the THS5671A output (i.e., OUT1 and/or OUT2) to extend its output compliance should size R_{LOAD} accordingly.

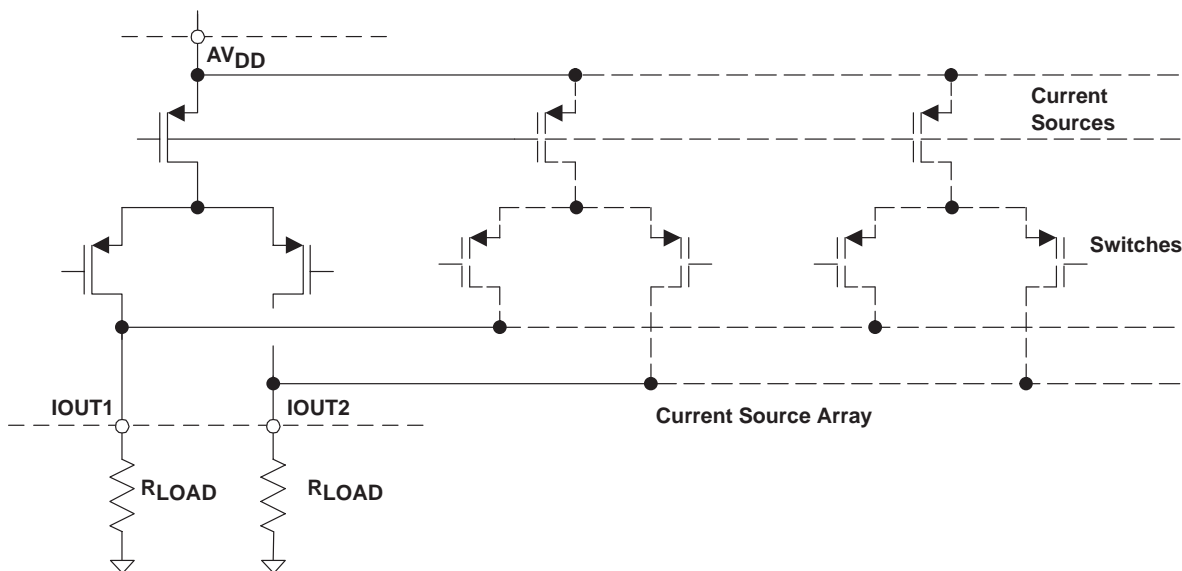

Figure 32. Equivalent Analog Current Output

Figure 33(a) shows the typical differential output configuration with two external matched resistor loads. The nominal resistor load of 50 Ω will give a differential output swing of 2 V_{PP} when applying a 20 mA full-scale output current. The output impedance of the THS5671A depends slightly on the output voltage at nodes IOUT1 and IOUT2. Consequently, for optimum dc integral nonlinearity, the configuration of Figure 33(b) should be chosen. In this I–V configuration, terminal IOUT1 is kept at virtual ground by the inverting operational amplifier. The complementary output should be connected to ground to provide a dc current path for the current sources switched to IOUT2. Note that the INL/DNL specifications for the THS5671A are measured with IOUT1 maintained at virtual ground. The amplifier's maximum output swing and the DAC's full-scale output current determine the value of the feedback resistor R_{FB} . Capacitor C_{FB} filters the steep edges of the THS5671A current output, thereby reducing the operational amplifier slew-rate requirements. In this configuration, the op amp should operate on a dual supply voltage due to its positive and negative output swing. Node IOUT1 should be selected if a single-ended unipolar output is desirable.

APPLICATION INFORMATION

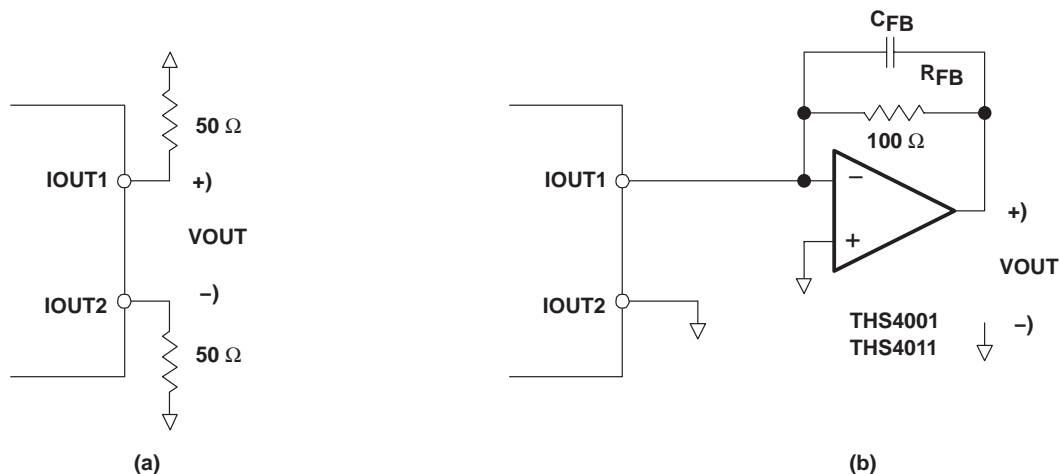

Figure 33. Differential and Single-Ended Output Configuration

The THS5671A can be easily configured to drive a doubly terminated 50-Ω cable. Figure 34(a) shows the single-ended output configuration, where the output current IOUT1 flows into an equivalent load resistance of 25 Ω. Node IOUT2 should be connected to ground or terminated with a resistor of 25 Ω. Differential-to-single conversion (e.g., for measurement purposes) can be performed using a properly selected RF transformer, as shown in Figure 34(b). This configuration provides maximum rejection of common-mode noise sources and even order distortion components, thereby doubling the power to the output. The center tap on the primary side of the transformer is connected to AGND, enabling a dc current flow for both IOUT1 and IOUT2. Note that the ac performance of the THS5671A is optimum and specified using this differential transformer coupled output, limiting the voltage swing at IOUT1 and IOUT2 to ±0.5 V.

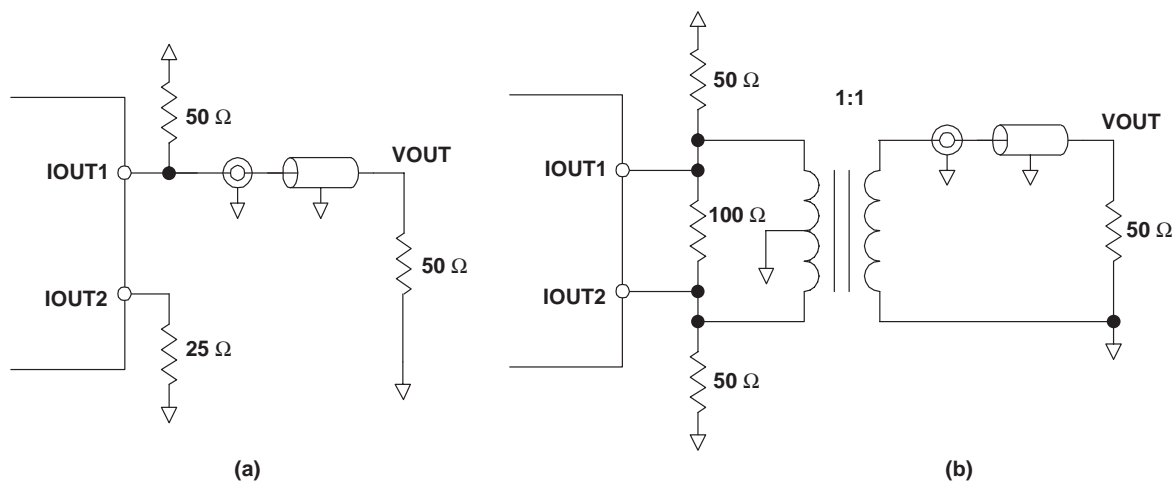

Figure 34. Driving a Doubly Terminated 50-Ω Cable

APPLICATION INFORMATION

sleep mode

The THS5671A features a power-down mode that turns off the output current and reduces the supply current to less than 5 mA over the analog supply range of 4.5 V to 5.5 V and temperature range. The power-down mode is activated by applying a logic level 1 to the SLEEP pin (e.g., by connecting pin SLEEP to AVDD). An internal pulldown circuit at node SLEEP ensures that the THS5671A is enabled if the input is left disconnected. Power-up and power-down activation times depend on the value of external capacitor at node SLEEP. For a nominal capacitor value of 0.1 μ F power down takes less than 5 μ s, and approximately 3 ms to power backup. The SLEEP mode should not be used when an external control amplifier is used, as shown in Figure 31.

definitions of specifications and terminology

integral nonlinearity (INL)

The relative accuracy or integral nonlinearity (INL), sometimes referred to as linearity error, is the maximum deviation of the output from the line between zero and full scale excluding the effects of zero code and full-scale errors.

differential nonlinearity (DNL)

The differential nonlinearity (DNL), sometimes referred to as differential error, is the difference between the measured and ideal 1 LSB amplitude change of any two adjacent codes. Monotonic means the output voltage changes in the same direction (or remains constant) as a change in the digital input code.

offset error

Offset error is defined as the deviation of the output current from the ideal of zero at a digital input value of 0.

gain error

Gain error is the error in slope of the DAC transfer function.

signal-to-noise ratio + distortion (S/N+D or SINAD)

S/N+D or SINAD is the ratio of the rms value of the output signal to the rms sum of all other spectral components below the Nyquist frequency, including harmonics but excluding dc. The value for S/N+D is expressed in decibels.

spurious free dynamic range (SFDR)

SFDR is the difference between the rms value of the output signal and the rms value of the largest spurious signal within a specified bandwidth. The value for SFDR is expressed in decibels.

total harmonic distortion (THD)

THD is the ratio of the rms sum of the first six harmonic components to the rms value of the fundamental signal and is expressed in decibels.

output compliance range

The maximum and minimum allowable voltage of the output of the DAC, beyond which either saturation of the output stage or breakdown may occur.

settling time

The time required for the output to settle within a specified error band.

glitch energy

The time integral of the analog value of the glitch transient.

APPLICATION INFORMATION

definitions of specifications and terminology (continued)

offset drift

The change in offset error versus temperature from the ambient temperature ($T_A = 25^\circ\text{C}$) in ppm of full-scale range per $^\circ\text{C}$.

gain drift

The change in gain error versus temperature from the ambient temperature ($T_A = 25^\circ\text{C}$) in ppm of full-scale range per $^\circ\text{C}$.

reference voltage drift

The change in reference voltage error versus temperature from the ambient temperature ($T_A = 25^\circ\text{C}$) in ppm of full-scale range per $^\circ\text{C}$.

THS5671A evaluation board

An evaluation module (EVM) board for the THS5671A digital-to-analog converter is available for evaluation. This board allows the user the flexibility to operate the THS5671A in various configurations. Possible output configurations include transformer coupled, resistor terminated, and inverting/noninverting amplifier outputs. The digital inputs are designed to interface with the TMS320 C5000 or C6000 family of DSPs or to be driven directly from various pattern generators with the onboard option to add a resistor network for proper load termination.

See the *THS56x1 Evaluation Module User's Guide* for more details (SLAU032).

APPLICATION INFORMATION

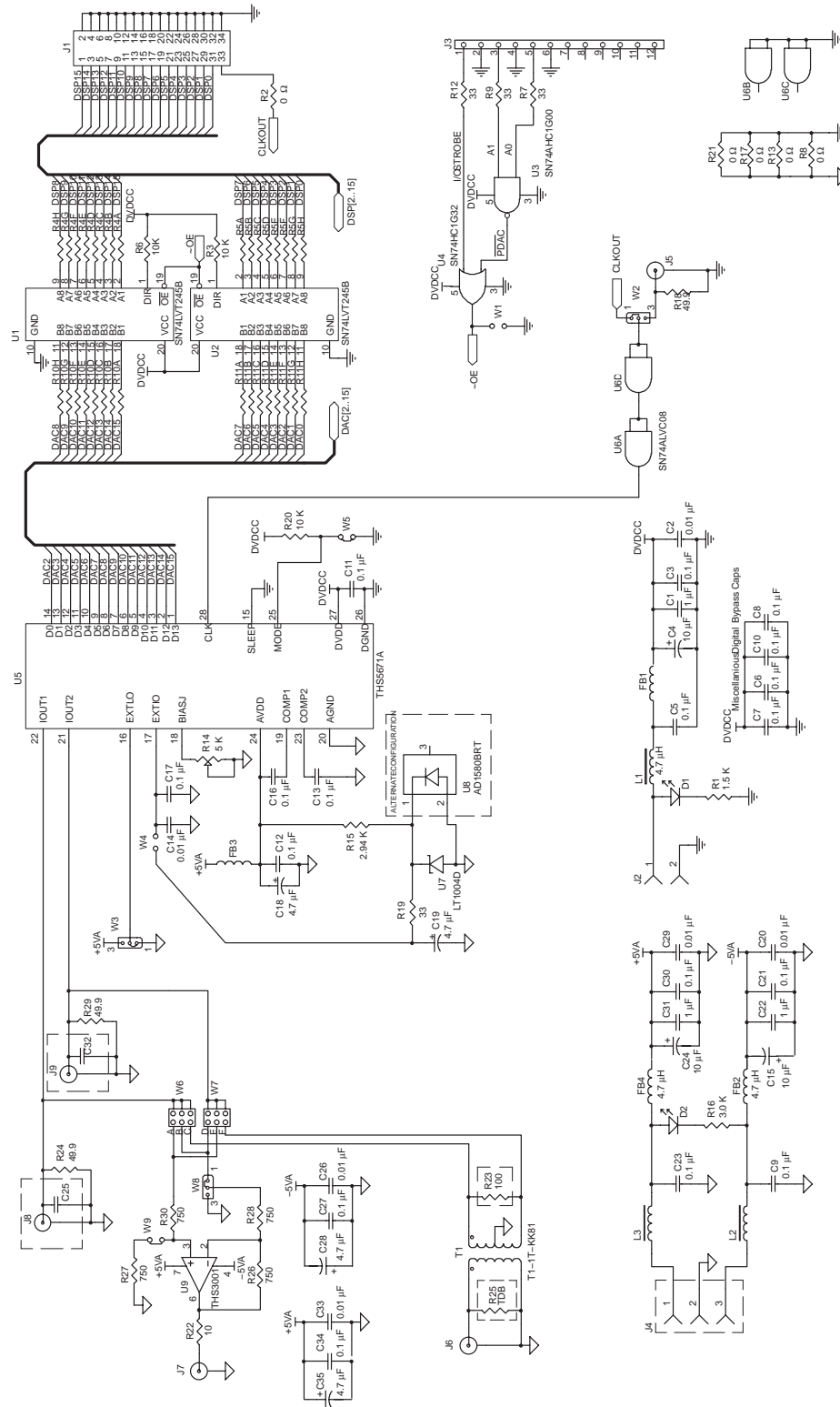

Figure 35. Schematic

APPLICATION INFORMATION

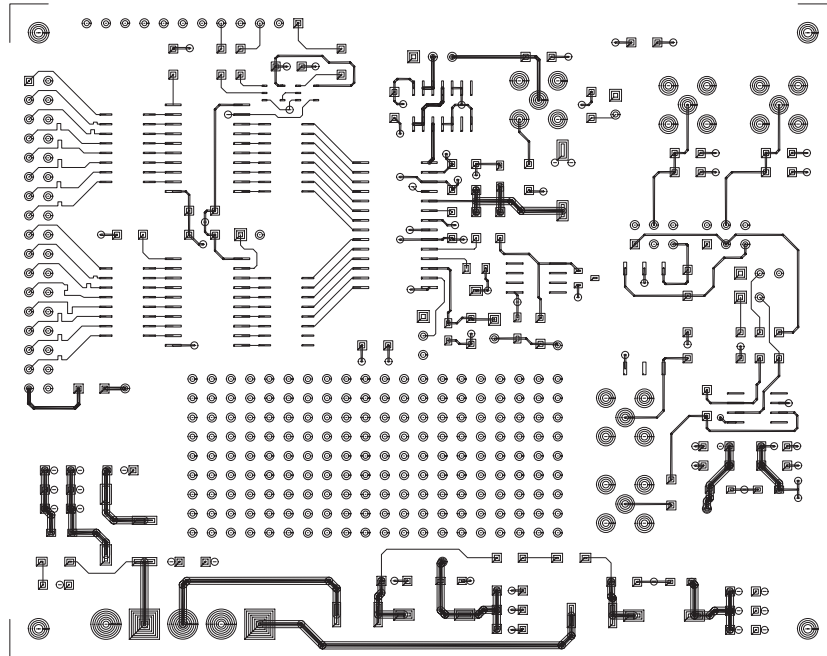

Figure 36. Board Layout, Layer 1

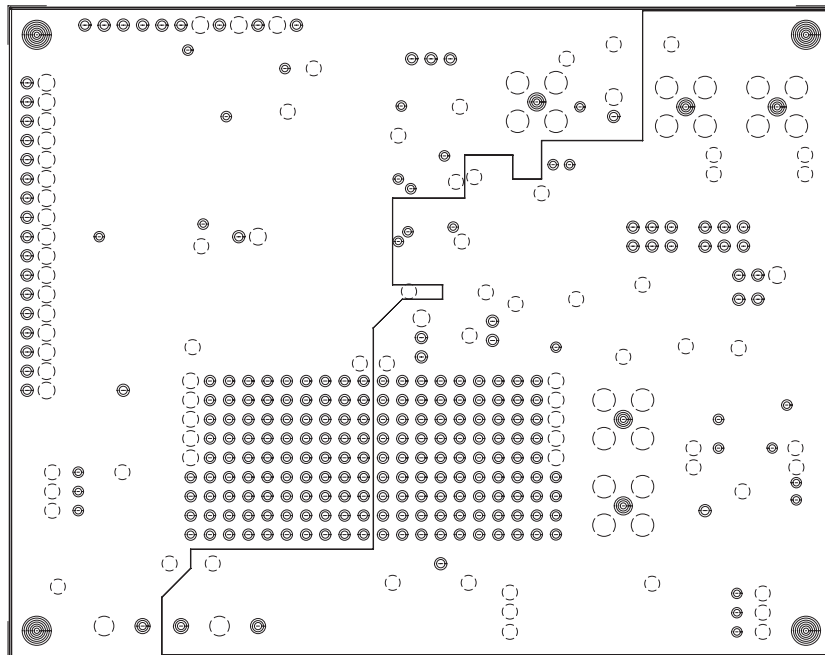

Figure 37. Board Layout, Layer 2

APPLICATION INFORMATION

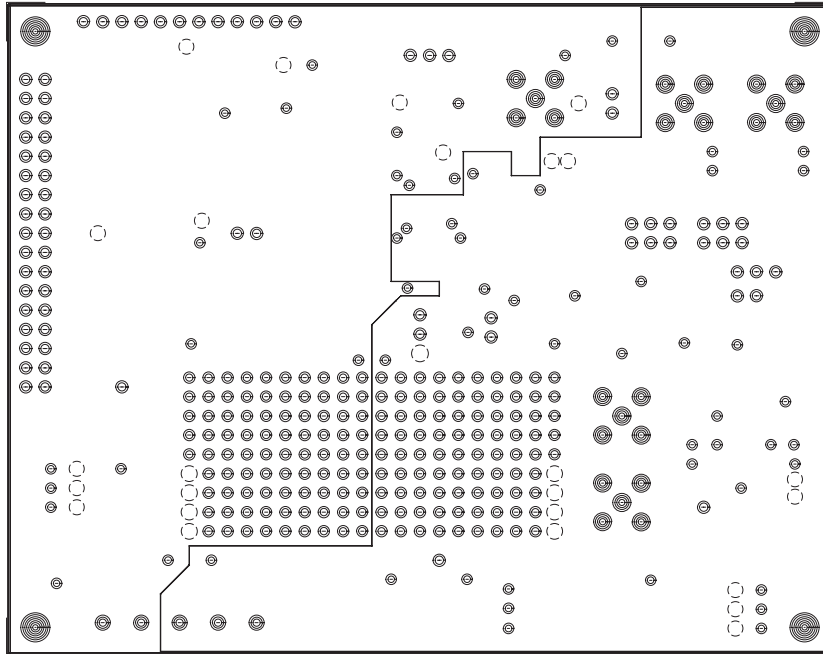

Figure 38. Board Layout, Layer 3

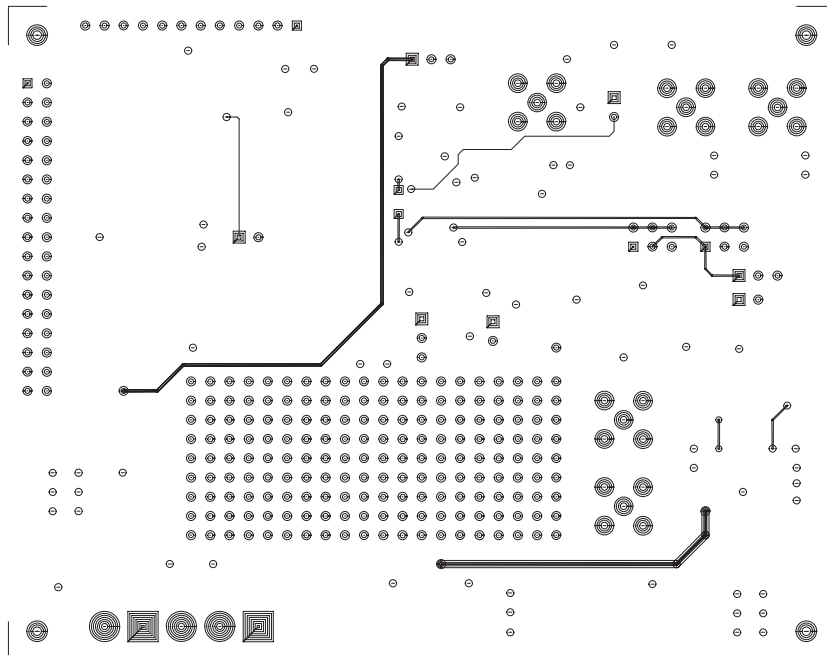

Figure 39. Board Layout, Layer 4

THS5671A
14-BIT, 125 MSPS, CommsDAC™
DIGITAL-TO-ANALOG CONVERTER

SLAS201A – DECEMBER 1999 – REVISED SEPTEMBER 2002

APPLICATION INFORMATION

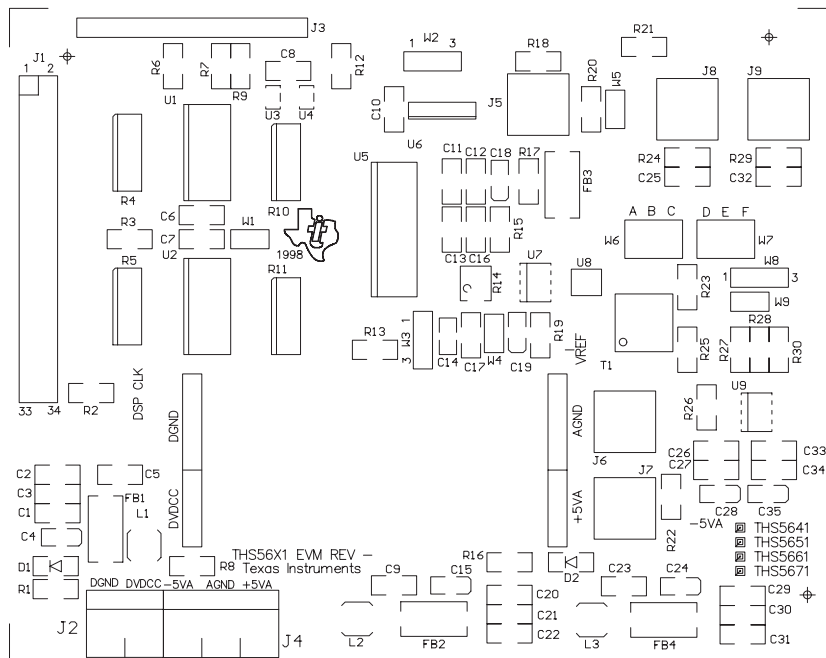

Figure 40. Board Layout, Layer 5

Table 2. Bill of Materials

QTY	REF. DES	PART NUMBER	DESCRIPTION	MFG.
3	C1, C22, C31	1206ZC105KAT2A	Ceranucm 1 µF, 10 V, X7R, 10%	AVX
4	C18, C19, C28, C35	ECSTOJY475	6.3 V, 4.7 µF, tantalum	Panasonic
3	C15, C24, C4	ECSTOJY106	6.3 V, 10 µF, tantalum	Panasonic
0	C25, C32		Ceramic, not installed, 50 V, X7R, 10%	
6	C14, C2, C20, C26, C29, C33	12065C103KAT2A	Ceramic, 0.01 µF, 50 V, X7R, 10%	AVX
17	C10, C11, C12, C13, C16, C17, C21, C23, C27, C3, C30, C34, C5, C6, C7, C8, C9	12065C104KAT2A	Ceramic, 0.1 µF, 50 V, X7R, 10%	AVX
2	D1, D2	AND/AND5GA or equivalent	GREEN LED, 1206 size SM chip LED	
4	FB1, FB2, FB3, FB4	27-43-037447	Fair-Rite SM beads #27-037447	FairRite
1	J1	TSW-117-07-L-D or equivalent	34-Pin header for IDC	Samtec
1	J2	KRMZ2 or equivalent	2 Terminal screw connector, 2TERM_CON	Lumberg
1	J3	TSW-112-07-L-S or equivalent	Single row 12-pin header	Samtec
1	J4	KRMZ3 or equivalent	3 Terminal screw connector	Lumberg
3	J5, J6, J7	142-0701-206 or equivalent	PCB Mount SMA jack, SMA_PCB_MT	Johnson Components
0	J8, J9	142-0701-206 or equivalent	PCB Mount SMA jack, not installed	Johnson Components
3	L1, L2, L3	DO1608C-472	DO1608C-series, DS1608C-472	Coil Craft
1	R1	1206	1206 Chip resistor, 1.5K, 1/4 W, 1%	
4	R10, R11, R4, R5	CTS/CTS766-163-(R)330-G-TR	8 Element isolated resistor pack, 33 Ω	



APPLICATION INFORMATION

Table 2. Bill of Materials (Continued)

QTY	REF. DES	PART NUMBER	DESCRIPTION	MFG.
4	R12, R19, R7, R9	1206	1206 Chip resistor, 33 Ω, 1/4 W, 1%	
5	R13, R17, R2, R21, R8	1206	1206 Chip resistor, 0 Ω, 1/4 W, 1%	
1	R14	3214W-1-502 E or equivalent	4 mm SM Pot, 5K	Bourns
1	R15	1206	1206 Chip resistor, 2.94K, 1/4 W, 1%	
1	R16	1206	1206 Chip resistor, 3K, 1/4 W, 1%	
3	R18, R24, R29	1206	1206 Chip resistor, 49.94K, 1/4 W, 1%	
3	R20, R3, R6	1206	1206 Chip resistor, 10K, 1/4 W, 1%	
1	R22	1206	1206 Chip resistor, 10K, 1/4 W, 1%	
1	R23	1206	1206 Chip resistor, 100K, 1/4 W, 1%	
1	R25	1206	1206 Chip resistor, TBD, 1/4 W, 1%	
4	R26, R27, R28, R30	1206	1206 Chip resistor, 750K, 1/4 W, 1%	
1	T1	T1-1T-KK81	RF Transformer, T1-1T-KK81	MiniCircuits
2	U1, U2	SN74LVT245BDW	Octal bus transceiver, 3-state, SN74LVT245B	TI
1	U3	SN74AHCT1G00DBVR/ SN74AHC1G00DBVR	Single gate NAND, SN74AHC1G00	TI
1	U4	SN74AHCT1G32DBVR/ SN74AHC1G32DBVR	Single 2 input positive or gate, SN74AHC1G32	TI
	THS5641	THS5641IDW	DAC, 3–5.5 V, 8 Bit, 100 MSPS	TI
	THS5651A	THS5651AIDW	DAC, 3–5.5 V, 10 Bit, 125 MSPS	TI
	THS5661A	THS5661AIDW	DAC, 3–5.5 V, 12 Bit, 125 MSPS	TI
	THS5671A	THS5671AIDW	DAC, 3–5.5 V, 14 Bit, 125 MSPS	TI
1	SN74ALVC08	SN74ALVC08D	Quad AND gate	TI
1	LT1004D	LT1004CD-1-2/LT1004ID-1-2	Precision 1.2 V reference	TI
0	NOT INSTALLED	AD1580BRT	Precision voltage reference, not installed	
1	THS3001	THS3001CD/THS2001ID	THS3001 high-speed op amp	TI
4	W2	TSW-102-07-L-S or equivalent	2 position jumper_.1" spacing, W2	Samtec
3	W3	TSW-102-07-L-S or equivalent	3 position jumper_.1" spacing, W3	Samtec
2	2X3_JUMPER	TSW-102-07-L-S or equivalent	6-Pin header dual row, 0.025×0.1, 2X3_JUMPER	Samtec

MECHANICAL DATA

PW (R-PDSO-G)**

PLASTIC SMALL-OUTLINE PACKAGE

14 PINS SHOWN

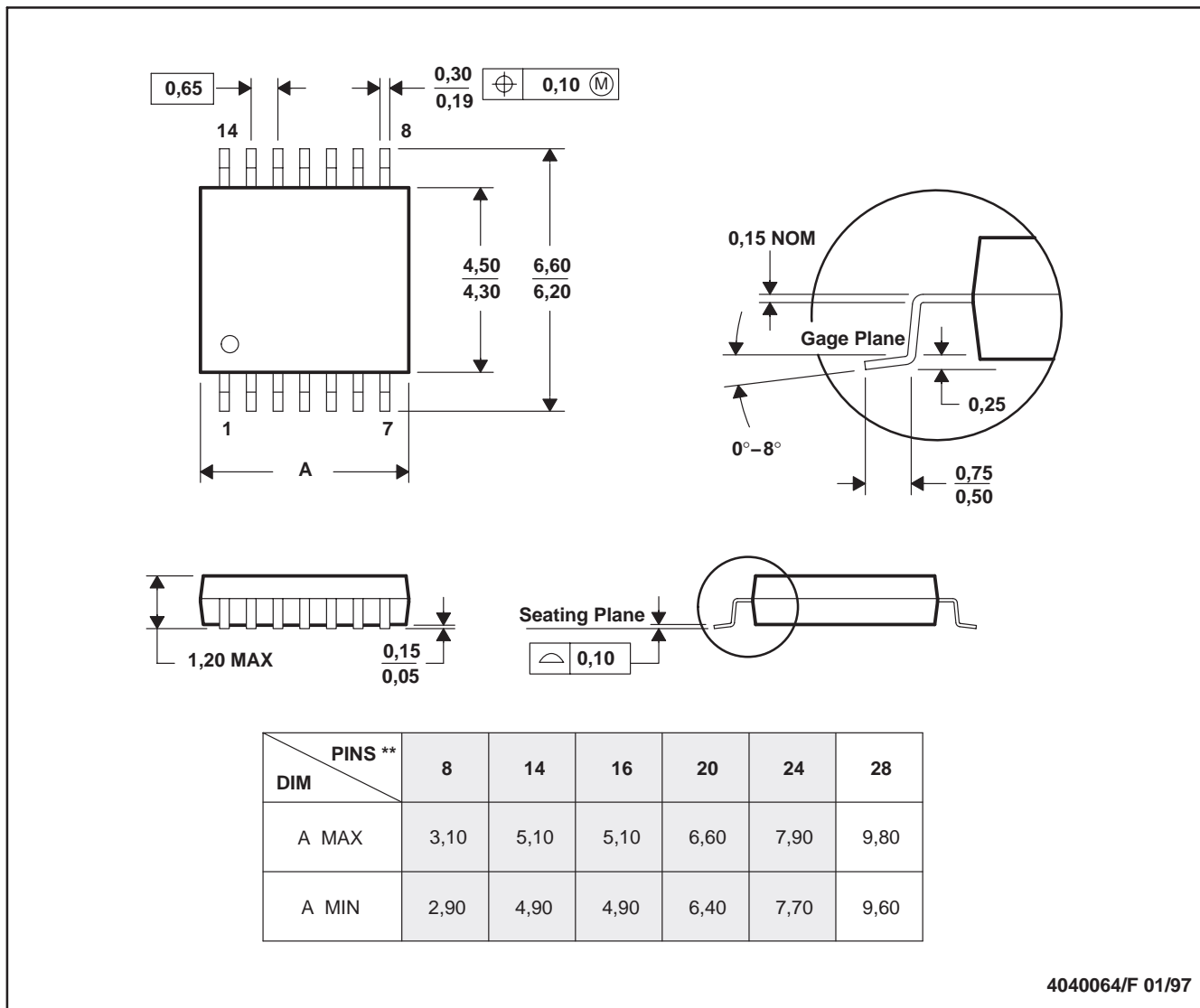

- NOTES: A. All linear dimensions are in millimeters.
 B. This drawing is subject to change without notice.
 C. Body dimensions do not include mold flash or protrusion not to exceed 0,15.
 D. Falls within JEDEC MO-153

PACKAGING INFORMATION

Orderable Device	Status ⁽¹⁾	Package Type	Package Drawing	Pins	Package Qty	Eco Plan ⁽²⁾	Lead/Ball Finish	MSL Peak Temp ⁽³⁾
THS5671AIDW	ACTIVE	SOIC	DW	28	20	Green (RoHS & no Sb/Br)	CU NIPDAU	Level-1-260C-UNLIM
THS5671AIDWG4	ACTIVE	SOIC	DW	28	20	Green (RoHS & no Sb/Br)	CU NIPDAU	Level-1-260C-UNLIM
THS5671AIPW	ACTIVE	TSSOP	PW	28	50	Green (RoHS & no Sb/Br)	CU NIPDAU	Level-1-260C-UNLIM
THS5671AIPWG4	ACTIVE	TSSOP	PW	28	50	Green (RoHS & no Sb/Br)	CU NIPDAU	Level-1-260C-UNLIM
THS5671AIPWR	ACTIVE	TSSOP	PW	28	2000	Green (RoHS & no Sb/Br)	CU NIPDAU	Level-1-260C-UNLIM
THS5671AIPWRG4	ACTIVE	TSSOP	PW	28	2000	Green (RoHS & no Sb/Br)	CU NIPDAU	Level-1-260C-UNLIM

⁽¹⁾ The marketing status values are defined as follows:

ACTIVE: Product device recommended for new designs.

LIFEBUY: TI has announced that the device will be discontinued, and a lifetime-buy period is in effect.

NRND: Not recommended for new designs. Device is in production to support existing customers, but TI does not recommend using this part in a new design.

PREVIEW: Device has been announced but is not in production. Samples may or may not be available.

OBSOLETE: TI has discontinued the production of the device.

⁽²⁾ Eco Plan - The planned eco-friendly classification: Pb-Free (RoHS), Pb-Free (RoHS Exempt), or Green (RoHS & no Sb/Br) - please check <http://www.ti.com/productcontent> for the latest availability information and additional product content details.

TBD: The Pb-Free/Green conversion plan has not been defined.

Pb-Free (RoHS): TI's terms "Lead-Free" or "Pb-Free" mean semiconductor products that are compatible with the current RoHS requirements for all 6 substances, including the requirement that lead not exceed 0.1% by weight in homogeneous materials. Where designed to be soldered at high temperatures, TI Pb-Free products are suitable for use in specified lead-free processes.

Pb-Free (RoHS Exempt): This component has a RoHS exemption for either 1) lead-based flip-chip solder bumps used between the die and package, or 2) lead-based die adhesive used between the die and leadframe. The component is otherwise considered Pb-Free (RoHS compatible) as defined above.

Green (RoHS & no Sb/Br): TI defines "Green" to mean Pb-Free (RoHS compatible), and free of Bromine (Br) and Antimony (Sb) based flame retardants (Br or Sb do not exceed 0.1% by weight in homogeneous material)

⁽³⁾ MSL, Peak Temp. -- The Moisture Sensitivity Level rating according to the JEDEC industry standard classifications, and peak solder temperature.

Important Information and Disclaimer:The information provided on this page represents TI's knowledge and belief as of the date that it is provided. TI bases its knowledge and belief on information provided by third parties, and makes no representation or warranty as to the accuracy of such information. Efforts are underway to better integrate information from third parties. TI has taken and continues to take reasonable steps to provide representative and accurate information but may not have conducted destructive testing or chemical analysis on incoming materials and chemicals. TI and TI suppliers consider certain information to be proprietary, and thus CAS numbers and other limited information may not be available for release.

In no event shall TI's liability arising out of such information exceed the total purchase price of the TI part(s) at issue in this document sold by TI to Customer on an annual basis.

TAPE AND REEL INFORMATION



QUADRANT ASSIGNMENTS FOR PIN 1 ORIENTATION IN TAPE



*All dimensions are nominal

Device	Package Type	Package Drawing	Pins	SPQ	Reel Diameter (mm)	Reel Width W1 (mm)	A0 (mm)	B0 (mm)	K0 (mm)	P1 (mm)	W (mm)	Pin1 Quadrant
THS5671AIPWR	TSSOP	PW	28	2000	330.0	16.4	6.9	10.2	1.8	12.0	16.0	Q1

TAPE AND REEL BOX DIMENSIONS



*All dimensions are nominal

Device	Package Type	Package Drawing	Pins	SPQ	Length (mm)	Width (mm)	Height (mm)
THS5671AIPWR	TSSOP	PW	28	2000	346.0	346.0	33.0

IMPORTANT NOTICE

Texas Instruments Incorporated and its subsidiaries (TI) reserve the right to make corrections, modifications, enhancements, improvements, and other changes to its products and services at any time and to discontinue any product or service without notice. Customers should obtain the latest relevant information before placing orders and should verify that such information is current and complete. All products are sold subject to TI's terms and conditions of sale supplied at the time of order acknowledgment.

TI warrants performance of its hardware products to the specifications applicable at the time of sale in accordance with TI's standard warranty. Testing and other quality control techniques are used to the extent TI deems necessary to support this warranty. Except where mandated by government requirements, testing of all parameters of each product is not necessarily performed.

TI assumes no liability for applications assistance or customer product design. Customers are responsible for their products and applications using TI components. To minimize the risks associated with customer products and applications, customers should provide adequate design and operating safeguards.

TI does not warrant or represent that any license, either express or implied, is granted under any TI patent right, copyright, mask work right, or other TI intellectual property right relating to any combination, machine, or process in which TI products or services are used. Information published by TI regarding third-party products or services does not constitute a license from TI to use such products or services or a warranty or endorsement thereof. Use of such information may require a license from a third party under the patents or other intellectual property of the third party, or a license from TI under the patents or other intellectual property of TI.

Reproduction of TI information in TI data books or data sheets is permissible only if reproduction is without alteration and is accompanied by all associated warranties, conditions, limitations, and notices. Reproduction of this information with alteration is an unfair and deceptive business practice. TI is not responsible or liable for such altered documentation. Information of third parties may be subject to additional restrictions.

Resale of TI products or services with statements different from or beyond the parameters stated by TI for that product or service voids all express and any implied warranties for the associated TI product or service and is an unfair and deceptive business practice. TI is not responsible or liable for any such statements.

TI products are not authorized for use in safety-critical applications (such as life support) where a failure of the TI product would reasonably be expected to cause severe personal injury or death, unless officers of the parties have executed an agreement specifically governing such use. Buyers represent that they have all necessary expertise in the safety and regulatory ramifications of their applications, and acknowledge and agree that they are solely responsible for all legal, regulatory and safety-related requirements concerning their products and any use of TI products in such safety-critical applications, notwithstanding any applications-related information or support that may be provided by TI. Further, Buyers must fully indemnify TI and its representatives against any damages arising out of the use of TI products in such safety-critical applications.

TI products are neither designed nor intended for use in military/aerospace applications or environments unless the TI products are specifically designated by TI as military-grade or "enhanced plastic." Only products designated by TI as military-grade meet military specifications. Buyers acknowledge and agree that any such use of TI products which TI has not designated as military-grade is solely at the Buyer's risk, and that they are solely responsible for compliance with all legal and regulatory requirements in connection with such use.

TI products are neither designed nor intended for use in automotive applications or environments unless the specific TI products are designated by TI as compliant with ISO/TS 16949 requirements. Buyers acknowledge and agree that, if they use any non-designated products in automotive applications, TI will not be responsible for any failure to meet such requirements.

Following are URLs where you can obtain information on other Texas Instruments products and application solutions:

Products

Amplifiers	amplifier.ti.com
Data Converters	dataconverter.ti.com
DSP	dsp.ti.com
Clocks and Timers	www.ti.com/clocks
Interface	interface.ti.com
Logic	logic.ti.com
Power Mgmt	power.ti.com
Microcontrollers	microcontroller.ti.com
RFID	www.ti-rfid.com
RF/IF and ZigBee® Solutions	www.ti.com/lprf

Applications

Audio	www.ti.com/audio
Automotive	www.ti.com/automotive
Broadband	www.ti.com/broadband
Digital Control	www.ti.com/digitalcontrol
Medical	www.ti.com/medical
Military	www.ti.com/military
Optical Networking	www.ti.com/opticalnetwork
Security	www.ti.com/security
Telephony	www.ti.com/telephony
Video & Imaging	www.ti.com/video
Wireless	www.ti.com/wireless

Mailing Address: Texas Instruments, Post Office Box 655303, Dallas, Texas 75265
Copyright © 2008, Texas Instruments Incorporated